

elektor

70
February 1981
U.K. 60p
U.S.A. \$2

up-to-date electronics for lab and leisure

Surinder Singh

High Com

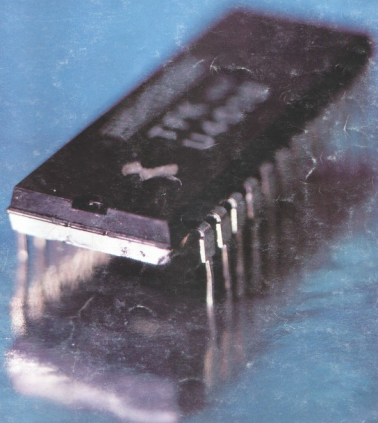

the latest
noise reduction system

Australia \$ 3*
Austria S. 76
Belgium F. 126
Canada \$ 3.50
Denmark Kr. 20

France F. 16
Germany DM. 8.80
Netherlands DFL. 7.50
New Zealand \$ 3
Norway Kr. 20
Sweden Kr. 28
Switzerland F. 9.20

*recommended

The new **MAPLIN** CATALOGUE is out on December 5th

A massive new catalogue from Maplin that's bigger and better than ever before. If you ever buy electronic components this is the one catalogue you must not be without. Over 300 pages, it's a comprehensive guide to electronic components with thousands of photographs and illustrations and page after page of invaluable data. We stock just about every useful component you can think of. In fact, well over 5000 different lines, many of them hard to get from anywhere else. Hundreds and hundreds of fascinating new lines, more data, more pictures and a new layout to help you find things more quickly.

MAPLIN

Maplin Electronic Supplies Ltd
All mail to: P.O. Box 3, Rayleigh, Essex S56 8LR
Telephone: Southend (0702) 554153 Sales (0702) 552911
Shops:
159-161 King Street, Hammersmith, London W6 Telephone: (01) 748 0926
284 London Road, Westcliff-on-Sea, Essex Telephone: Southend (0702) 554000.
Both shops closed Mondays.



On sale
in all branches
of W H Smith
from Dec 5th
price £1

Breadboard 1980
26th to 30th November
Open 10 a.m. till 6 p.m. (and till
8 p.m. Thursday, 4 p.m. Sunday)
Royal Horticultural Halls,
Elverson Street, London
(at St. James's Park Underground)
Visit our huge stand and
see our new 'single-chip' organ,
a new sequencer/composer,
and lots more.
Don't miss it!!

Post this coupon now for your copy of our 1981 catalogue price £1.

Please send me a copy of your 320 page catalogue. I enclose £1 (Plus 25p p&p). If I am not completely satisfied I may return the catalogue to you and have my money refunded. If you live outside the UK send £1.68 or 12 International Reply Coupons.

I enclose £1.25

Name

Address

E282.

elektor	2-01
audio power meter	2-03
noise reduction	2-04
Noise reduction systems have been in the news for about ten years and this article takes a look at the various systems currently available. Particular emphasis is paid to the High-Com system from Telefunken as this will form the basis of a constructional project in the near future.	
process timer (J. Meyer)	2-10
This timer will indicate the different time periods for the development, stop bath, fixing and rinsing phases and in the correct order by means of calibrated cards.	
high voltage from 723	2-14
An economical and effective way of achieving a stabilised 60 V power supply is by 'floating' the well known 723.	
juniors growing up	2-16
A survey of the proposed extensions for the Junior Computer.	
the voiced/unvoiced detector (F. Visser)	2-17
The finishing touch to the Elektor vocoder is presented in this article on the voiced/unvoiced detector combined with a noise generator.	
coming soon	2-26
emergency brake for the power supply	2-26
Faster than a fuse in those situations where it matters.	
150 W DC to DC converter for the car	2-27
This article describes a converter which will provide up to 60 V from the car power supply.	
low noise 2 metre pre-amp	2-32
2½ digit DVM	2-33
Three displays, six ICs and a handfull of components are the only ingredients needed to cook up this digital voltmeter.	
wagnephon (Dr. Wagner)	2-36
A simple answer for those readers who would like to play the piano but are unable to.	
bookshop	2-39
market	2-40
missing link	2-44
advertisers index	UK 22

contents

conten

cont

con

Soundings

EDITOR:

W. van der Horst

UK EDITORIAL STAFF

T. Day E. Rogans

P. Williams

TECHNICAL EDITORIAL STAFF

J. Barendrecht

G.H.K. Dam

P. Holmes

E. Krepelsauer

G. Nachbar

A. Nachtmann

K.S.M. Walraven



Why the Sinclair ZX80 is Britain's best-selling

Built: £99.⁹⁵

Including VAT, post and packing, free course in computing, free mains adaptor.

Kit: £79.⁹⁵

Including VAT, post and packing, free course in computing.

This is the ZX80. A really powerful, full-facility computer, matching or surpassing other personal computers at several times the price. 'Personal Computer World' gave it 5 stars for 'excellent value'. Benchmark tests say it's faster than all previous personal computers.

Programmed in BASIC - the world's most popular language - the ZX80 is suitable for beginners and experts alike. And response from enthusiasts has been tremendous - over 20,000 ZX80s have been sold so far!

Powerful ROM and BASIC interpreter

The 4K BASIC ROM offers remarkable programming advantages:

- * Unique 'one-touch' key word entry: the ZX80 eliminates a great deal of tiresome typing. Key words (RUN, PRINT, LIST, etc.) have their own single-key entry.
- * Unique syntax check. A cursor identifies errors immediately.
- * Excellent string-handling capability - takes up to 26 string variables of any length. All strings can undergo all relational tests (e.g. comparison).
- * Up to 26 single dimension arrays.
- * FOR/NEXT loops nested up to 26.
- * Variable names of any length.
- * BASIC language also handles full Boolean arithmetic, condition expressions, etc.
- * Randomise function, useful for games and secret codes, as well as more serious applications.
- * Timer under program control.
- * PEEK and POKE enable entry of machine code instructions.
- * High-resolution graphics.
- * Lines of unlimited length.

Unique RAM

The ZX80's 1K-BYTE RAM is the equivalent of up to 4K BYTES in a conventional computer - typically storing 100 lines of BASIC.

No other personal computer offers this unique combination of high capability and low price.

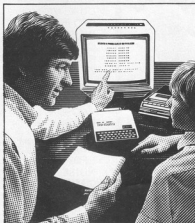

The ZX80 as a family learning aid. Children of 10 years and upwards are quick to understand the principles of computing - and enjoy their personal computer.

The Sinclair teach-yourself BASIC manual

If the specifications of the Sinclair ZX80 mean little to you - don't worry. They're all explained in the specially-written 128-page book (free with every ZX80). The book makes learning easy, exciting and enjoyable, and represents a complete course in BASIC programming - from first principles to complex programs.

Kit or built - it's up to you

In kit form, the ZX80 is pleasantly easy to assemble, using a fine-tipped soldering iron. And you may already have a suitable mains adaptor - 600 mA at 9V DC nominal unregulated. If not, see the coupon.

Both kit and built versions come complete with all necessary leads to connect to your TV (colour or black and white) and cassette recorder. Plug in and you're ready to go. (Built versions come with mains adaptor.)

personal computer.

Now available for the ZX80... New 16K-BYTE RAM pack



Massive add-on memory. Only £49.95.

The new 16K-BYTE RAM pack is a complete module designed to provide you—and your Sinclair ZX80—with massive add-on memory. You can use it for those really long and complex programs—or as a personal database. (Yet it can cost as little as half the price of competitive add-on memory for other computers.)

For example, you could write an interactive or 'conversational' program to show people what your ZX80 can do. With 16K-BYTES of RAM, they could be talking to your computer for hours!

Or you can store a mass of data—perhaps in a fairly simple program—such as a name and address list, or a telephone directory.

And by linking a number of separate programs together into one giant, but modular, program, you can achieve the same effect as loading several programs at once.

We're also confident that it won't be long

before you can buy cassette-based software using the full 16K-BYTE RAM. So keep an eye on the personal computer magazines—and brush up your chess perhaps!

The RAM pack simply plugs into the existing expansion port on the rear of the ZX80. No wires, no soldering. It's a matter of seconds and you don't need another power supply. You can only add one RAM pack to your ZX80—but with 16K-BYTES who could want more!

How to order

Demand for the ZX80 exceeds all other personal computers put together! So use the coupon to order today for the earliest possible delivery. All orders will be despatched in strict rotation. We'll acknowledge each order by return, and tell you exactly when your ZX80 will be delivered. If you choose not to wait, you can cancel your order immediately, and your money will be refunded at once. Again, of course, you may return your ZX80 as received within 14 days for a full refund. We want you to be satisfied beyond all doubt—and we have no doubt that you will be.

To: Science of Cambridge, FREEPOST 7, Cambridge CB2 1YY.

Remember: all prices shown include VAT, postage and packing. No hidden extras. Please send me:

Qty	Item	Code	Item price £	Total £
	Sinclair ZX80 Personal Computer kit(s). Price includes ZX80 BASIC manual, excludes mains adaptor.	02	79.95	
	Ready-assembled Sinclair ZX80 Personal Computer(s). Price includes ZX80 BASIC manual and mains adaptor.	01	99.95	
	Mains Adaptor(s) (600 mA at 9V DC nominal unregulated)	03	8.95	
	16K-BYTE RAM pack(s).	18	49.95	
	Sinclair ZX80 Manual(s). (Manual free with every ZX80 kit or ready-made computer).	06	5.00	

NB: Your Sinclair ZX80 may qualify as a business expense.

TOTAL: £

I enclose a cheque/postal order payable to Science of Cambridge Ltd for £ _____

Please print

Name: Mr/Mrs/Miss _____

Address _____

FREEPOST—no stamp needed.

ELK02

sinclair ZX80

Science of Cambridge Ltd.

6 Kings Parade, Cambridge, Cambs., CB2 1SN.
Tel: 0223 311488.

selektor SELEKTOR

Digital video

New signal processing concepts in TV technology

Digital technology has been part and parcel of television equipment, especially in remote control devices, for quite some time. Nowadays, however, even video signals are being processed by digital means. At the Valvo semiconductor plant in Hamburg, research led to the production of an integrated analogue to digital converter which includes a digital filter and PAL decoder for colour television. This system can also be used to eliminate 'ghosting' caused by multipath reflections.

Semiconductor manufacturers endeavour to integrate as many circuit functions as possible of a particular device onto a single silicon 'chip'. Conventional signal processing technology in television sets is principally analogue, even though bipolar integrated circuits are now being incorporated to a large extent. Further integration as far as analogue technology is concerned will be somewhat limited. For instance, the single chip colour decoder already contains just about everything that could possibly be integrated. The remaining external components, such as piezoceramic delay lines and filters, are as yet 'unintegratable' and in any case, they require extensive alignment. The logical solution lies therefore in digital techniques. It is hoped that digitisation will achieve the following objectives:

1. Further integration
2. Systems which will not require (manual) adjustment and which can be controlled by microprocessors, enabling them to be adapted for various designs and signal sources by means of software.
3. Improved picture quality without long term drift and new technical possibilities such as the elimination of ghosting.

The road to digitisation is by no means easy. Because of the high (6 MHz) signal frequencies involved, total integration of a digital video system like the colour decoder can only be achieved with the highest technology available.

Concepts

The colour decoder can be considered to be the key towards digital video systems. The components that are required are:

- fast analogue to digital converters
- digital filters
- microcomputers

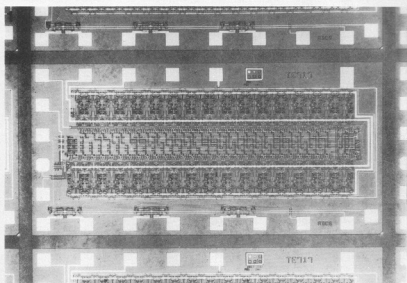

Figure 1. The photograph shows a single chip high-speed 6-bit analogue to digital converter manufactured using NMOS technology. The maximum clock frequency is around 20 MHz (!) while the device dissipation is a mere 300 mW.

2

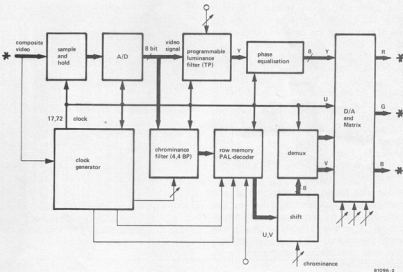

Figure 2. The block diagram of the digital PAL decoder currently being developed at Valvo. In addition to a programmable digital filter the system contains a phase equaliser to effectively eliminate 'ghosting'.

Fortunately, all of these components can be made up from 'standard' (bipolar) parts. However, by using VLSI (Very Large Scale Integration) MOS techniques it has now become possible to develop a fast analogue to digital converter having the following characteristics:

- active IC surface approximately 2 mm^2
- clock rate for A/D conversion $> 20 \text{ MHz}$
- device dissipation $< 300 \text{ mW}$

The internal view of the VLSI A/D converter is shown in figure 1. Until very recently similar high speed analogue to

digital converters could only be manufactured using bipolar technology. Rapid developments in VLSI technology, however, enabled MOS circuits to operate so fast that even video signals can now be processed by a single chip. Following the development of the fast

selektor SELEKTOR

selektor 2020

A/D converter came research into using the same techniques for a digital PAL decoder. Initially tests were carried out with a multitude of standard Schottky TTL devices. Figure 2 shows the block diagram of how five double sized eurocards were arranged to produce the required result. One of these eurocards is shown in figure 3. It contains a digital luminance filter operating at a frequency of four times that of the sub-carrier (17.73 MHz). The next step in the process is illustrated in figure 4. Here the entire luminance filter has been compressed into a single chip with a surface area of a few square millimetres.

The experimental set-up included both programmable digital luminance and chrominance filters and a digital delay line for the PAL decoder. The system was connected to a colour television which had been especially modified for the purpose and the excellent properties of the digital decoder were demonstrated to the technical press. The programmable characteristics of the luminance filter (see figure 5) enabled the picture to be brought into much better focus (due to aperture correction). It also proved that an 8-bit definition for the analogue to digital conversion of the composite video signal was more than adequate. Even if this were reduced to five bits it would hardly affect the picture quality.

It was also found that 'ghosting' due to multipath reflections could be impressively reduced by means of phase equalisation. The ghosts are literally driven from the screen! This solves a problem that was previously thought to be insurmountable.

Now that video is 'going digital' the trend should catch on in other fields as well. Digital records and tape recorders (audio) have been promised for the near future; next in line are digital stereo decoders, preamplifiers, duplexers and equalisers. The digital amplifier already exists.

selektor 2020

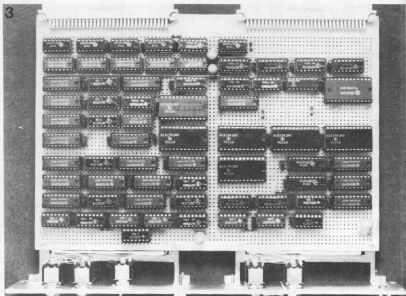

Figure 3. One of the double sized eurocards containing the digital luminance filter made up with easily obtainable Schottky TTL components.

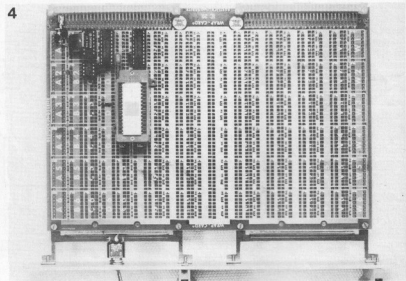

Figure 4. The same luminance filter after integration. The surface area of the chip is only a few square millimetres.

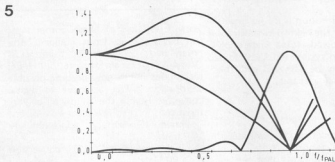

Figure 5. The amplitude curve of the digital luminance and chrominance filters. The programmable characteristics of the luminance filter (the graph shows three different curves) provide much better focusing of the picture (aperture correction).

Although this power meter was initially designed as an accessory for the 200 W power amplifier described in the January 1981 edition of Elektor, it can also be used with virtually any other amplifier with one proviso... as the specification of the above amplifier is 200 W into 4 Ω , this power meter has been designed to be compatible with 4 Ω loudspeakers. In addition, the unit has two ranges: 0... 50 W and 0... 200 W. The easiest way to understand how the power meter works is to examine the circuit diagram.

ing coil meter, a good quality power meter with a linear scale can be realised.

As mentioned previously, the power meter has been equipped with two ranges: one for high power - 200 W, and one for low(er) power - 50 W. This is taken care of by the two potential divider networks, R1/R2/R4 and R3/P1/R4, and the range switch S1. Neither network has to be a precision type as the circuit is calibrated by means of the two preset potentiometers P1 and P2. On the other hand,

audio power meter

There now appears to be a great demand for a visual indication of the amount of output power available from a particular amplifier. This is especially true if a great deal of time and money has been spent on building such an amplifier. The circuit described here is intended primarily for use with the 200 watt power amplifier design published in last month's issue of Elektor, however, there is no reason why it could not be used with other amplifiers. The unit utilises a moving coil meter to give a linear indication of the power level being fed to the loudspeakers.

Circuit

As can be seen from figure 1, the circuit diagram of the audio power meter could hardly be called complex. Very few components are needed to construct the complete unit. The circuit would even be simpler if the requirement was for a logarithmic rather than a linear scale.

How does it work? The majority of readers will know that the output of an amplifier is proportional to the square of the output voltage:

$$P = \frac{U_{\text{eff}}^2}{R_L}$$

Thus, by merely measuring the output voltage, a power meter with a logarithmic scale can be obtained. In this particular instance use is made of the I/V characteristics of a germanium diode by feeding the amplifier output signal to a bridge rectifier via a potential divider. Provided the voltage across the diode bridge remains below about 1.4 V, the I/V curve will be exponential. This means that the current flowing through the diodes will be proportional to the square of the output voltage (U_{eff}^2). By monitoring this current with a mov-

ing coil meter, a good quality power meter with a linear scale can be realised.

Calibration

The output of the power amplifier is loaded with a 4 Ω resistor - not a loudspeaker. The power meter is then connected in parallel with this resistor. A 1 kHz signal is then fed to the input of the amplifier and the output voltage monitored with a multimeter (30 V AC or greater).

With the range switch in the '200 W' position the volume of the amplifier can be turned up slowly. It is important to keep an eye on the meter while doing this so that if the needle looks like bending itself around the end stop, P2 can be adjusted to compensate. When the multimeter indicates an output voltage of 28.3 V, the power output will be exactly 200 W. Potentiometer P2 is then adjusted to give a full scale reading on the power meter. The amplifier volume is then turned down until a reading of 14.1 V is indicated on the multimeter. Switch S1 is then placed in the '50 W' position and P1 adjusted to give a full scale reading once more. ■

1

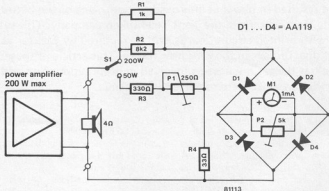
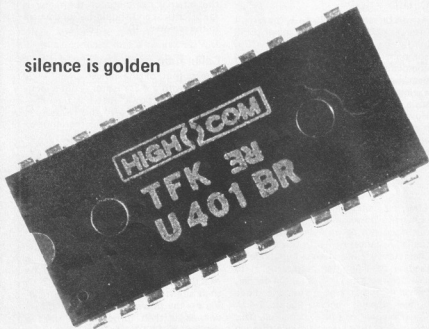

Figure 1. The potential dividers R1/R2/R4 and R3/P1/R4 ensure that the voltage across the bridge rectifier never exceeds about 1 V. The diodes will then operate in the non-linear area of their I/V curves so that the current through them will be exponential in relation to the voltage across the bridge.

noise reduction

silence is golden



Noise reduction systems, the electronic kind, have been in the news off and on for about ten years, since the compact cassette became popular in fact. Technology moves on however and recent developments in this field have resulted in new and improved systems. One of the better ones is the High Com from the giant Telefunken company. This system, together with printed circuit boards, will be featured by Elektor as a constructional project in the very near future. This article proposes to take a look at the various aspects involved in noise suppression and to compare the foremost systems currently available.

The market for noise reduction systems has seen numerous changes in recent years. It all began to happen in 1966 with the arrival of the professional Dolby A system which soon became part and parcel of every self-respecting studio. The arrival of the compact cassette and the ensuing argument of tape versus cassette quality, made a ready market for a simplified Dolby noise reduction circuit. This was of course the Dolby B system which fitted the bill very nicely. Philips, the inventors of the cassette itself, followed up shortly after with their DNL (Dynamic Noise Limiter). It was not too difficult to see which of the two in existence would be suitable for home construction. On the one hand, the Dolby B system was fairly complicated, requiring a great deal of skill and calibration on the part of the builder (even if the ICs were available). On the other hand, the Philips DNL was not as effective as the Dolby but was very much simpler and was offered free to the world... no licences required. This of course presented a far better prospect to the home constructor.

In retrospect the DNL could not survive commercially. The world-wide application of the Dolby B system in top quality cassette decks made it the industry standard and this, together with the availability of 'Dolby-ised' cassettes, allowed Dolby to monopolise the field of noise suppression for a very long time.

Recent advances in noise suppression

Japanese audio manufacturers in particular have been very busy trying to develop their own noise reduction systems. This is not so surprising since the use of the Dolby incurs very high licensing fees. With the production quantities involved in the Japanese export market, it would be very much cheaper for them to have their own system. Of course its specifications would have to be an improvement to make any significant headway.

The first manufacturer to follow in the wake of Dolby was JVC with the excellent ANRS and later the SUPER ANRS systems. Other Makers appeared on the scene, such as Toshiba with the ADRES, the DBX-11-124 from DBX, the PLUS-N-55 from Sanyo and the Phase Linear 1000, an auto-correlator system. Understandably, Dolby did not remain idle either, they produced the Dolby HX.

One name is missing from the above collection and that is the High Com by Telefunken. This is likely to become Dolby's number one rival, as more and more manufacturers are selecting it for their cassette decks.

There are so many systems available nowadays, that it is difficult to see the field for grass, not to mention the less

known makes like Burwen and numerous professional filters. The hobbyist is of course only interested in one aspect: which system is the best to build? Unfortunately, most manufacturers either refuse to disclose their technical recipes or ask exorbitant amounts for them. Elektor decided on Telefunken's High Com after intensive and extensive research into the basic principles in which the reader is now invited to partipate.

Historic facts

Noise suppression systems all have one thing in common: they are designed to electronically eliminate noise as far as possible. This became paramount once the compact cassette was invented. This cheap form of sound recording so small in size and easy to use, soon became immensely popular, but the standard low tape speed of 4.75 cm per second caused quite a few problems, not the least of which was NOISE!

Is there any escape?

The noise we're talking about is peculiar to magnetic tape and so very difficult to get rid of. The tape consists of a carrier covered in a thin layer of magnetised particles (FeO_2 , CrO_2 or Fe). In the process of recording an audio signal on the tape the particles are magnetised by the recording head. Since the particles are not evenly distributed on the tape and therefore not equally magnetised, soft passages feature a high noise level that is especially audible at high frequencies.

There are two ways in which to reduce noise: by speeding up the tape or the use of higher modulation. The first method is out of the question, because the cassette is run at a standard speed. (Nowadays there are a few manufacturers who provide tape decks with a second tape speed of 9.5 cm per second.) This leaves the second option as the only possibility: make sure there are no soft passages on the tape.

Compressor + expander = compander

The first serious attempt to suppress noise by means of electronic circuits is attributed to Dolby. Basically, the system works as any other of its kind. The block diagram in figure 1 gives a general idea of what happens within a complete recording and playback channel. During recording the dynamic range of the signal is compressed and expanded again when the tape is played back. The term dynamic range is very important in this respect, extending from the loudest to the softest signal to be recorded. Peak modulation is usually indicated as 0 dB. Thus, the lowest

1

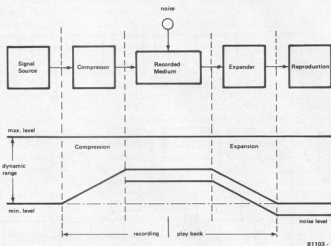

Figure 1. What the compander consists of and what it does to the dynamic range.

2

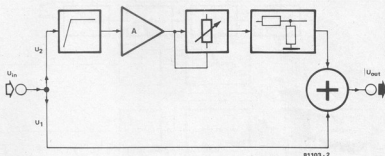

Figure 2. The block diagram of the DNL system. This will only work during playback.

signal to go on tape (cassette) will be about 56 dB below that level. Considering the dynamic range of a high quality record is 65 dB, cassette recording means a loss of almost 10 dB to start with. When a record is taped on a cassette deck the difference between them is very noticeable. The wide dynamic range so characteristic of records is largely lost.

The drawing in figure 1 gives a simplified version of a noise reduction system. Below the block diagram the drawing shows what happens to the dynamic range during various stages. During recording the level of the input signal is lowered to a value the tape can accept (including a certain safety threshold). During playback the dynamic range is 'retranslated' into the original value by the expander. This maintains the noise level beneath the lowest signal level recorded, so that (theoretically) it should no longer be audible. The entire noise suppression system is called

a compander (a combination of COMPRESSOR and exPANDER).

Controlled filters

At this point a small digression is called for. There is another form of noise suppression which only works during playback and only eliminates noise when it is a real nuisance: at high frequencies.

This type does not fall into the compander category, as it is a kind of controlled low-pass filter (where the slope of the curve can be determined). Professionals regularly use 'normal' low-pass filters. Unfortunately, however, they all have the same drawback in that they affect the original signal. In other words, what is needed is a system that removes the noise without influencing the original sound.

A typical example of a controlled filter is the well-known DNL unit (see the

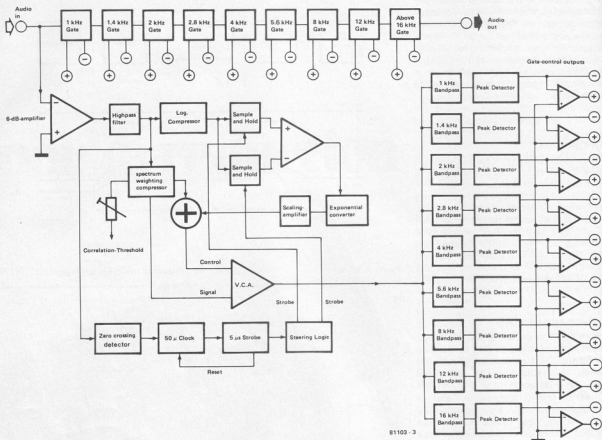
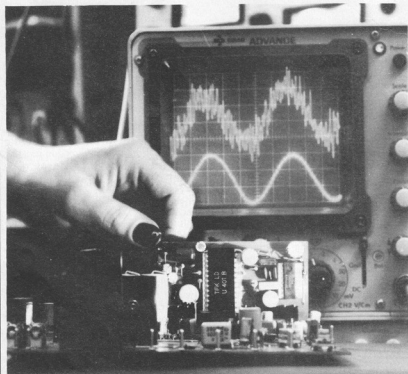

Figure 3. This very elaborate block diagram shows the auto-correlator by Phase Linear.



block diagram in figure 2). The input signal is first split up into two components, U_1 and U_2 . Signal U_1 proceeds directly to an adder circuit at the output. U_2 , on the other hand, passes through a high-pass filter and is then amplified. After this, the signal is reduced again by a dynamic attenuator, where the attenuation achieved depends on the level of the higher frequencies in the input signal. The entire circuit is preset so that the signals (U_1 and U_2) are equally large for signals above 4 kHz with a power 38 dB or more below the reference level, but at the same time they will be in phase opposition. In the adder circuit they cancel each other out. Thus, the noise or rather, high frequency suppression will only be successful within that range. Low and high frequencies with an amplitude greater than -38 dB will remain intact. The signal/noise ratio can be improved by about 3 dB with the aid of DNL.

The Phase Linear 1000 is a very elaborate system and certainly worth mentioning. This uses digital means to cut the noise level down. Figure 3 contains the block diagram representing this system. It involves an auto correlator which produces amazing results especially when

combined with Dolby-B and the 'downward expander' of the device. The input signal is divided into nine frequency bands and each one is examined for interference. The auto correlator 'looks at' the input signal, finds out which frequencies it contains and then connects the signal through to the output by way of the corresponding band-pass filters according to the signal's frequency distribution and level. A wonderful system but far from cheap. Its main advantage is that it can be used with every type of recording material.

Comanders

Most noise suppression systems are in fact comanders. This is largely due to

the fact that a noise reduction system is essential in a cassette recorder and a compander leads to good results without being complicated as a circuit.

Let's take a closer look at the main prototypes: DBX, Dolby and Telcom (the professional High Com).

Dolby was the first to come up with the idea of splitting the signal up into different frequency bands and to feed each one to its own control circuit so that each band can be compressed separately. During playback the signal is again divided into bands and each is attenuated according to its level.

Figure 4 shows the Dolby A system. The audio spectrum is split up into four bands, each with its own control system. A low-pass filter at the input makes sure that HF signals cannot ad-

versely affect the control system. Next the signal passes through an adder and subtractor circuit and is then split into four bands, one of over 9 kHz, over 3 kHz, between 80 Hz and 3 kHz and below 80 Hz. Every band has a voltage controlled amplifier (VCA) where amplification will depend on the average signal level in the band concerned. The four outputs of the VCAs are added together and during the recording they are added to the original signal and subtracted during playback. This professional Dolby system can suppress up to 10...12 dB of noise, which is fine.

The second brand on the list is the DBX version. Its block diagram (see figure 5) looks very straight forward compared to the Dolby. During the recording the signal first passes through a band-pass

4

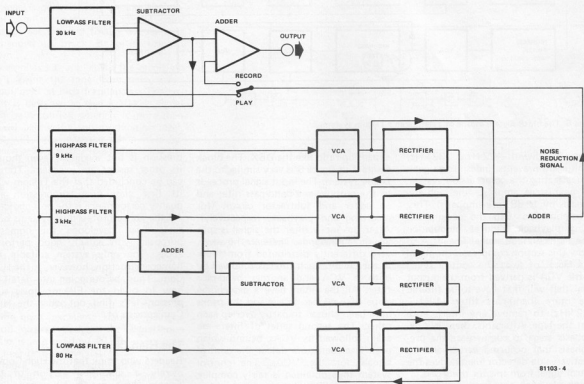

Figure 4. The block diagram of a professional Dolby system.

5

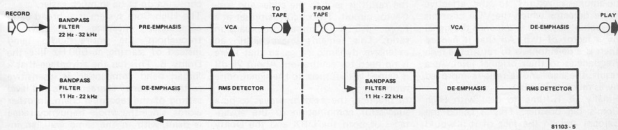

Figure 5. The block diagram of the DBX system looks remarkably straight forward.

6

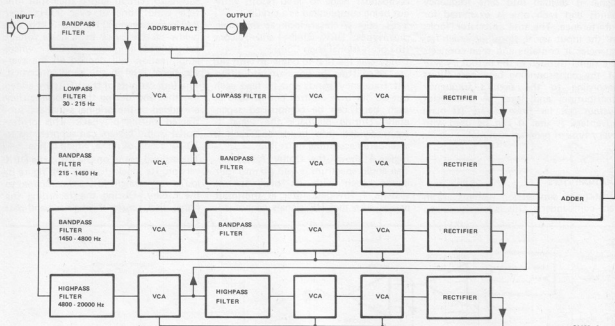

Figure 6. The block diagram of one of Telefunken's Telcom systems.

filter (bandwidth 22 Hz... 32 kHz) which again prevents undesirable signals from affecting the compression system. The next stage amplifies the high frequencies by 12 dB (pre-emphasis). This, in combination with the de-emphasis during playback, reduces modulation noise at high frequencies. The VCA to follow this section compresses the signal by a factor of two. The control signal for the VCA is derived from the output signal that will first have to be filtered once more (band-pass filter 11 Hz... 22 kHz) to remove any interference from the tape. After this, there is a de-emphasis stage to compensate the emphasis that occurred earlier and an effective value detector then derives the control signal from this for the VCA. During playback the same circuits are used as during the recording with the exception of the input filter. Only the configuration of the various blocks will be different. The input signal passes through the band-pass filter and after de-emphasis returns to the effective value detector which the VCA controls in such a way that it expands the signal by a factor of two. All that is needed then is a de-emphasis to return the high frequencies to their original level. As a result, the signal/noise ratio is improved by as much as 30 dB!

Finally, it is time to deal with High Com's big brother. This is called the Telcom and on the face of it it would appear to be a mixture of the DBX and Dolby systems, as on the one hand it uses several bands like the Dolby and on the other it has a fixed compression/

expansion ratio like the DBX. The block diagram in figure 6 is very similar to the Dolby system. The input signal proceeds to the output via a band-pass filter and an adder and subtractor circuit (for recording and playback, respectively). After the input filter the signal is split up into four bands. These are, however, very differently distributed from those in the Dolby. Each filter is followed by both a VCA and another band-pass filter. All the filters have a descending slope of 6 dB per octave and the peaks have been chosen to partly overlap each other. The second series of filters are again followed by VCAs, behind which peak level detectors detect the control signals for the VCAs. The control system thus obtained is fairly complex due to the filter combination and has the advantage that the system does not produce so much 'pumping' — which causes other systems a fair amount of trouble. The output signals of the first series of VCAs are added together and the result is sent to the adder and subtractor circuit. The circuit is preset at a fixed 1.5:1 compression/expansion ratio. This remains linear within an extensive dynamic range so that there is no need for calibration. About 25 dB is gained with respect to the signal/noise ratio.

In practice, the Telcom proves to be a successful combination of the advantages of both the DBX and the Dolby systems. Although the DBX suppresses noise very well, the system tends to be rather audible when readjusting. In comparison, the Dolby's noise sup-

pression is but mediocre, even though its other results are excellent. Thus it can be concluded that the Telcom with its first class noise suppression and quality performance is the best choice. All the above professional systems have since been developed for domestic purposes with equally good performances. The only system suitable for homeconstruction, however, is the High Com. Thus, before going into detail on how to build the Elektor noise suppressor, let's find out what the High Com consists of.

The High Com

Readers who think that the High Com is merely a simplified version of the Telcom, have got it all wrong. Surprisingly, it has certain advantages when compared to the latter. Obviously, the circuit had to be made less complex. In fact practically the entire compander fits into a single IC and this allows the construction to be so much easier.

The High Com system is a 'broad band compander', meaning that it works throughout the entire audio band instead of starting at 500 Hz like the Dolby B. This has the advantage that a 'broad band compander' is insensitive to the frequency characteristic and level setting of the recording chain. In other words, since the whole frequency range is dealt with in the same way, an incorrect level setting does not affect the frequency response (within the permissible range of levels).

Figure 7 shows the block diagram of the

High Com system. The blocks indicated as A are identical and consist of a stage to boost the high frequency. Behind this there is a voltage controlled amplifier. Block B is the expander and has the opposite transfer function as that of the A blocks. In addition, a kind of de-emphasis (block C) and pre-emphasis (blocks D) takes place. Finally, there are two rectifiers (E) which produce the control voltages for the various VCAs.

The signal passes through the circuit as follows. First the high frequencies of the input signal are amplified. Then the output signal derived from the VCA behind this is used to generate the control voltage. This requires an op-amp, a VCA, a pre-emphasis and a rectifier. Before the compressed signal reaches the recorder, it will initially pass through a de-emphasis phase. When the cassette is played, the opposite happens. First there is pre-emphasis, then the control voltage is derived with the aid of a circuit similar to the one in the compressor section and finally the signal is expanded in block B to its original form.

De-emphasis is applied to the recording to prevent the tape from being over-modulated at high frequencies. The circuit is designed so that a 10 kHz signal will be amplified when it is more than 12 dB below the top modulation level, but will be attenuated when it is between -12 and 0. Pre-emphasis has the exact opposite effect.

Figure 8 shows a graph of the compression and expansion curves of the High Com system. It can be seen to what extent a signal having a certain frequency and power (in terms of dB) is compressed and expanded. You would think a broad band compander's curves would be the same for all frequencies, nevertheless this is not the case since the high frequencies are boosted during compression.

There's no doubt about it, the High Com gives excellent results. Using a good quality cassette the signal/noise ratio is improved by 20 dB - you have to hear it to believe it!!

A more detailed description of the High Com will be given at a later date in an article devoted to the Elektor compander, a high quality noise suppression system. Until then keep the volume down...

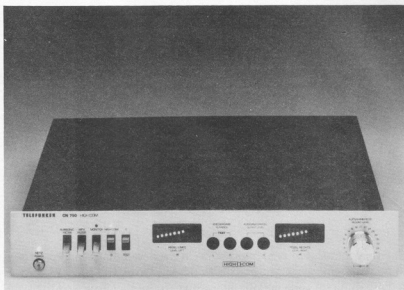

7

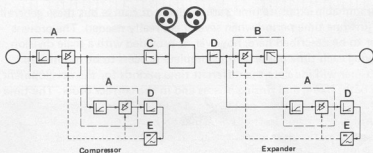

81103-7

Figure 7. This is the block diagram of the compressor and expander section of the High Com system.

8

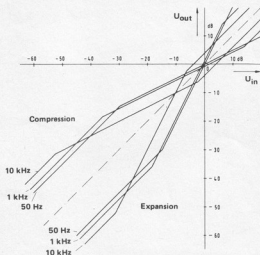

81103-8

Figure 8. A graph showing the compression and expansion curves of the High Com system at different frequencies. 0 dB corresponds to peak modulation.

J. Meyer

process-timer

The time factor is of vital importance in the development and printing in photography. Each process, development, fixing and rinsing, require different time periods depending on the chemicals and the type of paper used. In short, the whole process can become something of a hit and miss affair, especially if there are a pile of prints to produce. Programmable exposure timers are available of course but these generally give just one time period when several are really needed. The process timer to be described here, however, is provided with a scale division allowing each time phase of the complete process to be monitored. The timer will indicate the different time periods for the development, stop bath, fixing and rinsing phases and in the correct order. The time intervals are determined by the use of 'process' cards which are calibrated according to the film, paper and/or chemicals used. Thus for each combination of materials, a specific card will be needed. The application of the process timer does not have to end at photography. Any process that is divided into a series of timed events will find a use for this type of timer.

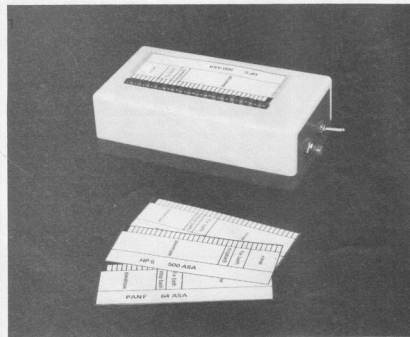

Photo 1. By providing the process timer with a suitable scale card it can be put to numerous uses.

Electronically, the process timer is not at all exceptional and uses only a handful of readily available CMOS chips. However, the method in which the parts have been put to use is novel. The process timer 'communicates' its activities by means of a row of LEDs in conjunction with a small process card (see photo 1). Pressing the start button will cause the first LED to light. After 30 seconds this will 'jump' to the second LED, a further interval of 30 seconds will cause the third LED to light and so on down the entire row of LEDs. A 'process' card, on which the various process time periods are calibrated in 30 second steps, is placed along the LED row. The lighted LED will now indicate on the card how far the process has progressed. If the process is to be temporarily halted, the interval switch can be operated and the timer will stop and await further instructions.

Take a practical example. It is required to develop a photograph and the process is indicated in four phases on the card. Other important factors are also included such as the temperature and type of chemicals and paper being used. The card is now placed alongside the row of LEDs. After exposure, the photographic paper is placed in the developing tray and the start button is pressed. The moment a LED indicates the end of the developing time period, the paper is taken out of the developer and placed in the stop bath. The timer will now continue to indicate 30 second intervals through this phase. It is easy to see that it is merely necessary to watch the LEDs to get a fairly accurate indication of the position of any phase in the complete development cycle.

If a different brand of paper and/or chemicals is to be used, a suitable process card can be designed (with 'experience' built in). There is now no longer any need for guess work since a practical 'experiment' can be made repeatable by marking the results directly onto the process card.

A further card indicating the cost of telephone calls could be used to alleviate that sinking feeling commonly felt in the wallet when the telephone bill arrives.

The circuit diagram

The timer has been designed with a battery supply in mind and for this reason CMOS ICs have been used. It will be obvious by this time that a shift register forms the heart of the electronics involved, in fact the 4015 CMOS IC. The LEDs in the display are connected directly to the outputs of the four registers, ICs 1...4. To reduce power consumption to a minimum the current through the LEDs is switched, by transistor T1, at a 2 Hz frequency and with a 50% duty cycle.

The clock generator is formed with gates N2 and N3 and the clock fre-

1

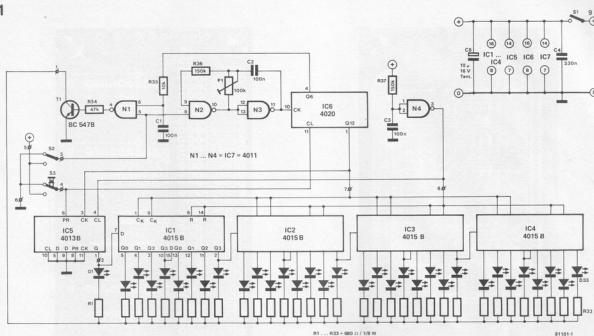

Figure 1. The process timer consists of a shift register made up of CMOS ICs.

frequency is divided by IC6. Pressing the start button (S3) will clear the counter and set the flipflop IC5 causing the LED D1 to flash. About 15 seconds after the start button is released the Q12 output of IC6 will go high. This will be the first clock pulse to the register and during its positive transition a '1' will be entered into IC1. Every 30 seconds thereafter, a clock pulse will appear at the Q12 output of IC6 and the '1', together with the flashing LED, will move along the LED display at the snail's pace of one 'jump' per 30 seconds.

When designing the process cards it will have to be taken into account that the first LED only flashes for 15 seconds, whereas the others light for 30 seconds. The initial 15 seconds can also be used to enable both hands to be free after pressing the start button, so that any last minute jobs that need to be dealt with before the process starts can be completed.

It was mentioned previously that switching the LED current on and off saves a considerable amount of energy. There is, however, another reason for this. When the outputs of the shift register sink the LED current, their voltage level will drop. In that case an input connected to one of the outputs will no longer recognise the level as being logic 1. To remedy this, the phase shift network R35/C1 ensures that transistor T1 stops conducting when a 1 level is being shifted. The outputs of the shift register will not be loaded at that moment so that everything will proceed as planned. Whenever the process is to be inter-

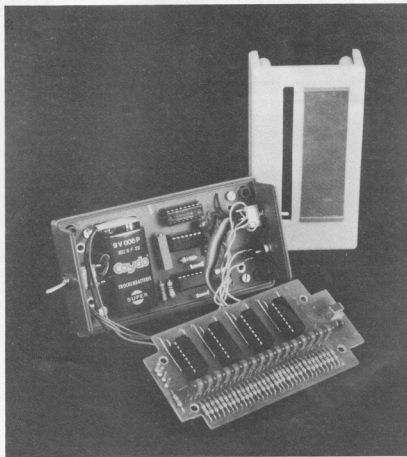

Photo 2. The electronics is spread over two boards, so that the entire circuit can easily be incorporated inside a small plastic case.

2

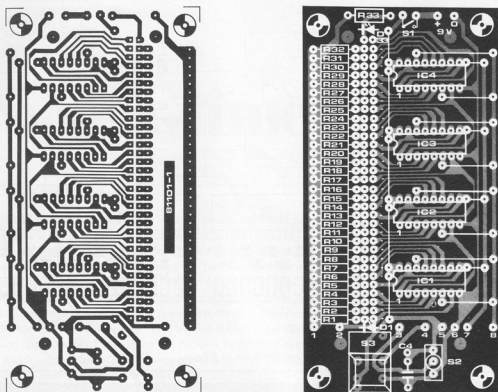

Figure 2. The printed circuit board and the component overlay of the two process timer boards.

3

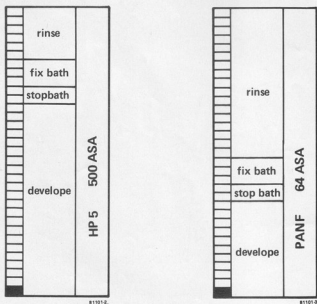

Figure 3. An illustration of a possible layout for the process cards.

Parts list**Resistors:**

R1 ... R33 = 680 Ω /1/8 W
 R34 = 47 k
 R35 = 10 k
 R36, R37 = 150 k
 P1 = 100 k preset pot

Capacitors:

C1 ... C3 = 100 n
 C4 = 330 n
 C5 = 10 μ /16 V tantalum

Semiconductors:

T1 = BC 547B
 IC1 ... IC4 = 4015B (buffered)
 IC5 = 4013B (buffered)
 IC6 = 4020
 IC7 = 4011
 D1 ... D33 = LED, 17 x (red)
 and 16 x (green)

Miscellaneous:

S1 = on/off switch
 S2 = single pole toggle switch
 S3 = single pole toggle push button (digitast)
 plastic case 120 x 65 x 40 mm (West Hyde
 or Electrovalue)

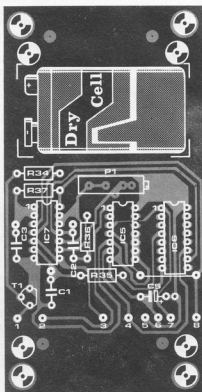
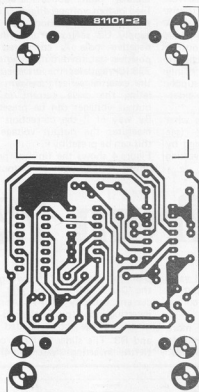

rupted this is merely a question of switching S2. The clock generator then stops and transistor T1 continues to conduct so that the display will remain lit. N4, R37 and C3 is a 'power-up' reset to make sure that the timer is reset when the supply voltage is switched on.

Construction

The electronics of this timer involves two printed circuit boards. This enables the entire circuit including a 9 V battery to be mounted in a small plastic case (a West Hyde or Electrovalue type, for instance - see photo 2).

The LED board is mounted inside the lid of the case, the other one in the base. The two boards are interconnected by means of a length of 8 way ribbon cable. A thin metal plate (see photo 1) is glued on top of the lid. The shortest two edges can be turned over to allow the process card to be slipped in.

It is best to use LEDs in two colours, say, red and green, and mount them alternately on the board, as this makes it easier to see the light 'jump'. The board is designed for rectangular LEDs but other types are equally suitable, provided their width does not exceed 2.54 mm. The process cards can be

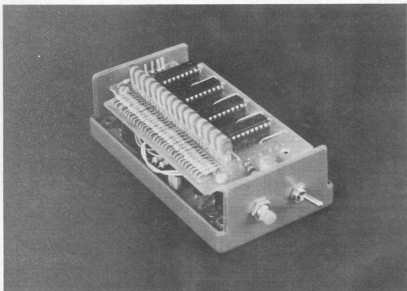

made from pieces of white cardboard. Once the scale division has been included, they can be covered in a protective layer of sellotape.

The process timer can be calibrated with an ordinary watch. Pot P1 is preset so

that the first LED will flash for precisely 15 seconds. The next LEDs will then each light for 30 seconds. The clock generator may also be preset at a different frequency to divide the process into larger or smaller steps.

up to 60 V with an IC

high voltage from 723

Hobbyists faced with having to build a power supply that can produce output voltages of 40 V and higher know that the only way to do this is to use discrete semiconductors. After all, the maximum input voltages of most integrated voltage regulators are nearly always too low. Even the best known voltage regulator IC, the 723, has a peak input of only 40 V and produces an output of not more than 37 V (see table 1). As it happens, this particular IC can make up for its own handicap. How? Read on . . .

Figure 1 gives a look inside the 723 IC. It contains a temperature compensated and relatively noise-free reference voltage source U_{ref} . From this a current of up to 15 mA can be derived. A correction amplifier controls a series transistor which provides the output voltage. In addition, there is a current limiting transistor enabling a highly stable and 'short' proof power supply to be constructed with only a few external components.

To see how it works, let's see what happens at a stabilised 5 V (see figure 2). A voltage of 5 V divided by R1 and R2 is at the non-inverting input.

This situation is called a 'floating regulator' since the auxiliary voltage literally 'floats' above the actual stabilised output voltage. Figure 3 illustrates this particular method. The auxiliary supply U2 serves to drive the IC, its negative pole is connected to the positive stabilised output voltage. The 723 IC regulates the drive current for the external series transistor. By regulating the drive current in parallel, output voltages can be preset at 0 V. By way of P the correction amplifier measures the output voltage so that this can be preset by P.

Figure 4 shows the finished product, a power supply with an output voltage

that can be preset anywhere within the 0 V . . . 60 V range and having a current capacity of 1 A. At the non-inverting input (pin 5) there is the reference voltage now divided by R2 and R3. The slider of P1 is connected to the inverting input (pin 4) of IC1.

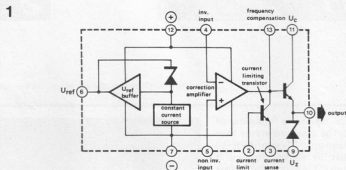

81017 1

Figure 1. The contents of the 723. It contains the active components required to form the basis of a highly stable power supply.

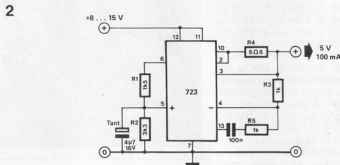

81017 2

Figure 2. A small 5 V/100 mA power supply. This simple circuit illustrates clearly how the IC works.

The correction amplifier will now compare the voltage at the slider of P1 to that at pin 5 and with the internal transistor connected as a parallel regulator it will control the base drive current of T1 across R5 and D5 in such a way that the two voltages become equal. If the one at pin 4 is too high so that the output voltage of the power supply is too low, the

base drive current of T1 will rise bringing the output voltage back to its correct value. With the given component values it is possible to preset the output from 0 V to 60 V with P1. As the resistance of P1 has a 10% tolerance P2 is included to pinpoint the peak output at exactly 60 V. The internal current limiter transistor can however not be used in this circuit, since it

would effect the exact opposite result. In other words, the output voltage would rise instead of drop!

For this reason T2 takes care of the current limitation. Table 2 gives an indication of the figures which can be obtained with this circuit. The advantage of a floating regulator is that the maximum output voltage is now only dependent on the U_{CE0} of the external series transistor and so the formulae for the values of R1 and R9 are as follows:

$$R1 \approx P2$$

$$P1 = 10 \text{ k}\Omega$$

$$U_{\text{max}} \geq 40 \text{ V}$$

$$R1 = 5.9 P1$$

$$R9 = P1 \times 1.2$$

R8 determines the maximum output current, therefore

$$R8 = \frac{0.65 \text{ V}}{I_{\text{max}}}$$

These formulae enable the circuit to cope with voltages of several kV depending on components used such as T1, D9, D10, etc.

When currents rise above 1 A, an eye will have to be kept on the dissipation of T1. For currents below 3 A the circuit in figure 5 can substitute T1. In this case, however, R8 will have to be reduced by 0.22Ω per 4 W.

3

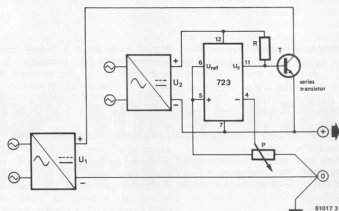

Figure 3. The block diagram of a floating regulator used with the 723 IC.

4

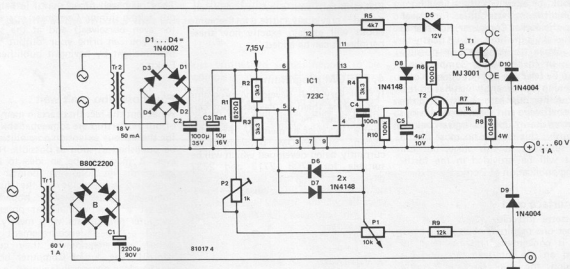

Figure 4. The complete circuit diagram of the power supply. It is short circuit proof and has an output voltage range of 0 V to 60 V.

Table 1 723 C

Operational voltage:	max. 40 V
Current from U_{ref} :	15 mA max.
Current from U_2 :	25 mA max. (DIL)
Output current:	200 mA max.
Dissipation:	900 mW max. (DIL)
Ripple suppression:	86 dB max. ($I_{\text{Cref}} = 5 \mu\text{F}$)
Temperature coefficient of the output voltage:	$0.015\%/k$ max.
U_{ref} :	$7.15 \text{ V} \pm 5\%$

Table 1. The technical data with reference to the voltage regulator IC 723. In the TO 100 version (metal case) U_2 is missing; dissipation is only 800 mW.

Table 2

Output voltage:	0 V to 60 V
Output current:	1 A max.
Load calibration ($I = 0 \text{ A to } 1 \text{ A}$):	0.1%
Output noise voltage:	$2 \text{ mV}_{\text{eff}}$

Table 2. The performance that can be achieved using the circuit in figure 4.

5

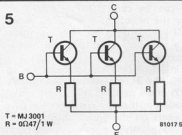

Figure 5. If this parallel circuit is used to replace T1 in figure 4, the supply can produce 3 A of current, provided the transformer, rectifier and filter electrolytic capacitor have corresponding values.

junior's growing up!

a survey of possible extensions

Since Elektor published the article on the Junior Computer (May 1980) the editorial office has been inundated with queries about expansion possibilities. Basically, it all boils down to: how can the Junior Computer be expanded and to what extent?

As would be expected, there are a number of different possibilities for 'developing' the Junior Computer, however to say 'the sky's the limit' would hardly be wise. When thinking about possible expansions for the Junior Computer it is best to be selective and not concern ourselves with equipment which has no real purpose. For this reason a 'listing' of the future hardware and software extensions has been drawn up and is given below. Obviously, this can be no more than a brief summary at this stage, but full details will be provided in the forthcoming publication of Books 2 and 3.

1. Interface card

A cassette interface seems to be the number one requirement as far as hardware is concerned. This has been included on the interface card and has provision for two separate cassette recorders. It is also compatible with the KIM microcomputer. The cassette interface can be controlled by means of either the hexadecimal keyboard or an ASCII keyboard (in the latter case there are a number of operational possibilities).

The interface card also contains 1 k of RAM (2 x 2114), user input/output (6522) and a standard RS 232 interface. In addition, there is provision for two IC sockets on the board which can be used for further memory expansion. One of the following memory devices can be inserted into each of the two sockets: 2708 (1 k EPROM), 2716 (2 k EPROM) or 8114 (1 k RAM). This adds up to a possible 3...5 k of extra memory.

2. Memory extension

An article describing the RAM/EPROM card was published in Elektor number 65 (September 1980) and in the following issue (number 66, October 1980) an explanation of how to connect it to the Junior Computer was given. We realise that the price of 2732 EPROMs may well exceed the budget of some of our readers and so we are currently examining ideas for developing a less expensive version — no promises, mind!

3. Hardware

Various peripheral devices can be connected to the computer such as a video interface and ASCII keyboard (the Elekterminal) and a printer. As mentioned previously, the forthcoming books will explain exactly how these peripherals can be added.

4. EPROM programmer

It's all very well developing programs and storing them on cassette, but certain routines are better stored permanently in system memory. For this reason, an EPROM programmer is currently being developed which will be suitable for 2708, 2716 and 2732 devices, including their derivatives such as those with JEDEC pinning. The programmer will consist of a basic unit with 'plug in' modules for the different device types.

5. Firmware

Bearing point 4 in mind, comprehensive editor, assembler and disassembler routines have been developed for use with an ASCII keyboard (Elekterminal) and a printer. These routines will enable you to develop, debug and list programs quickly and efficiently.

6. Suggestions

A host of items are still the subject of discussion. Any useful suggestions that readers may have will be more than welcome. For example, would you like to be able to program your Junior Computer in a high level language? If so, which one? BASIC? Extended or Tiny? Broad Scots or Scouse? Or would you prefer to jump in at the deep end with

Pascal? How about a floppy disc and graphics? Send your answers on a post-card please to No seriously, if you have any ideas please let us know (we are not yet capable of reading minds!!).

7. Software: user programs

Along the same lines, what sort of programs do you want to run on your Junior Computer? Games? Business? Accounts? There are far more interesting possibilities than digital clocks and reaction timers! Again, and even more important, have you any programs? If perchance you have written any interesting programs, don't be shy, send them to our editorial staff. They may well prove useful in helping out fellow Junior Computer operators (or even ourselves!) and at the same time you can bring your 'output' into the limelight by having it published in Elektor.

For those who can't wait . . .

We accept the fact that certain members of our readership are somewhat anxious for the various extension possibilities to be published as soon as possible. However, it may well be an idea to bear in mind the following points: By publishing the details of the Junior Computer project Elektor hoped to interest a large number of potential computer enthusiasts who merely required a bit of encouragement (together with equipment they could afford!). The Junior Computer books are therefore necessarily tailored to suit their tastes and requirements. Those of you who were already working with computers are bound to grow a little impatient at the step-by-step methods employed.

Another aspect worth considering is that Elektor does have a magazine to publish which contains various topics and projects that all require technical research. The neat double-sided main computer board and the interface card both required a large amount of time and effort to develop.

Think of it this way: when you go out to have a meal and a good time, you don't just pop around to the local 'chippy', you go to a proper restaurant. Bear with us, it will all be well worth waiting for!

the finishing touch to the Elektor vocoder

On the face of it, the detector may seem superfluous. However, when the block diagram of the complete vocoder in figure 1 is considered and the proposed additions are momentarily forgotten, their necessity will be readily apparent. In the upper section the speech signal is divided and split into control voltages to feed the VCA's in the synthesis section. The VCA's are thus provided with an input signal consisting of the carrier signal chopped into identical bits and pieces. Fair enough. In practice however, the synthesised result proves to be less satisfactory than expected. The fault lies with the carrier signal which is far from ideal.

remedy for this was the inclusion of the 'high frequency blend' provided by P17 shown in the dotted area in figure 1. Part of the 'high frequency' in the speech signal is taken from the high pass filter in the analysis section and is blended directly with the synthesised result. This is precisely what Harald Bode applies in his synthesiser. In practice this solves quite a few problems. For unvoiced signals to be properly synthesised, however, a circuit is required which can distinguish between the voiced and unvoiced sounds during analysis. Professionals call such a circuit a voiced/unvoiced detector and it is found in relatively few vocoders to

the voiced/unvoiced detector

This article presents the long awaited voiced/unvoiced detector and brings the series on the Elektor vocoder to a conclusion. The detector, combined with the noise generator, enables the unvoiced sounds (s, f, etc.) to be synthesised with ease. It successfully eliminates a minor shortcoming in the vocoder that was intended as a short term compromise.

date. The reason for this is largely due to the fact that the components required are fairly complex and therefore increase the price of the vocoder considerably. Technically speaking, it is by no means easy to design and this of course also deters many manufacturers. When it is combined with a noise generator a decent voiced/unvoiced detector is a great improvement on the blending trick mentioned earlier. The latter would not work, for instance, whenever speech is to be synthesised without an original speech signal. In other words, a microprocessor and a DA converter are

Most synthesised signals happen to be incomplete as far as their spectrum is concerned. This means that unvoiced sounds such as s, t, k and p do not come through very well, in fact they are often inaudible. The simple and *effective*

F. Visser

1

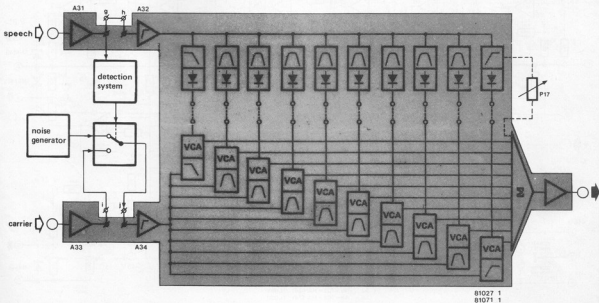

Figure 1. The block diagram of the vocoder including the extension described here. Potentiometer P17 will now be superfluous.

unable to generate a complete, artificial speech spectrum. The detection system described here can however do this. It enables noise to be fed to all the synthesis filters in the vocoder whenever there are unvoiced sounds in the speech signal. With the aid of control voltages derived from the analysis section the required 'colour' noise can be produced. In addition, the detector is fast enough to provide a very true-to-life synthesis of the s, t, k and p sounds.

How does it work?

Whereas the practical construction is rather complicated, the block diagram of a voiced/unvoiced detector is fairly straight forward. Figure 1 shows the general principle. The speech signal is fed to a suitable detection system that can distinguish between the unvoiced and voiced sounds. This detector operates a switching circuit which interrupts the carrier signal in the event of unvoiced sounds and then substitutes it temporarily for the output signal of a noise generator.

Clearly the detection system is at the heart of the matter, but the little block in the diagram hardly gives an indication of its function. What does it do exactly? Figure 2 illustrates the frequency ranges which the detector 'examines' before deciding whether the signal is voiced or unvoiced. The mere fact that there are many high frequencies in the speech signal does not mean that the speech

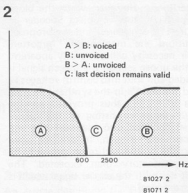

Figure 2. Only in the event of excessive frequencies in the speech signal and very low frequencies will the detector decide that the signal is unvoiced.

signal is unvoiced at that moment. This assumption is totally incorrect, as the high frequencies measured may well be part of a complex signal with a fundamental frequency that is so low that it is a voiced signal after all. That is why the detector also checks the low frequency range (down to 600 Hz). If at that moment the range does not include a signal, or if the signal is much smaller than its high frequency counterpart, chances are the sound is indeed unvoiced. Thus, two elements must be incorporated in the detection system:

a high pass filter with a cut-off frequency of about 2500 Hz and a low pass filter with a turnover point at about 600 Hz.

The voiced/unvoiced detector

The complete circuit diagram of the detector is given in figure 3. Points A, B and C of figures 3a and 3b are linked. Roughly speaking (there is a little more involved) the diagram in figure 3a constitutes the detection system and that in figure 3b the section drawn as a switch in the block diagram. Both circuits are mounted on a separate board. The noise generator is incorporated on a third board, but this will be dealt with later. First let us look at figure 3 in further detail. It can be seen that the speech signal derived from the vocoder initially reaches the buffer/amplifier A1 and is then split into two signals, each passing the filters mentioned above. The high pass is constructed around A2 and A3 and the low pass around A4 and A5. Their peak values are at 2500 Hz and 600 Hz, respectively. The two filter sections have a slope of 24 dB per octave to obtain the best possible separation. They are each followed by a rectifier (A6 and A8) and by a 12 dB/octave smoothing filter (A7 and A9). The latter's turnover frequencies are around 300 Hz for the high pass system and 30 Hz for the low.

The rectified and calibrated output signals are now fed to three amplifiers or comparators (A10, A11, A12) fol-

3a

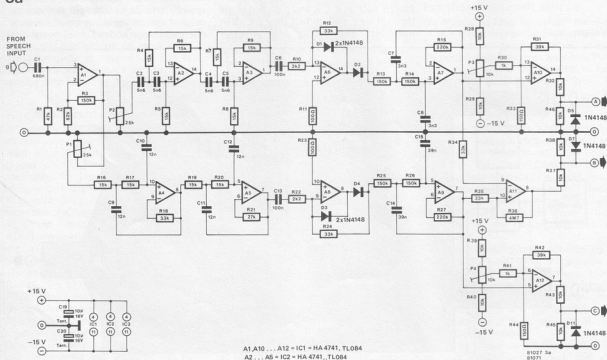

A1, A10, A11, A12 = IC1 = HA 4741, TL084
A2, A3, A5 = IC2 = HA 4741, TL084
A6, A7, A8, A9 = IC3 = HA 4741, TL084

3b

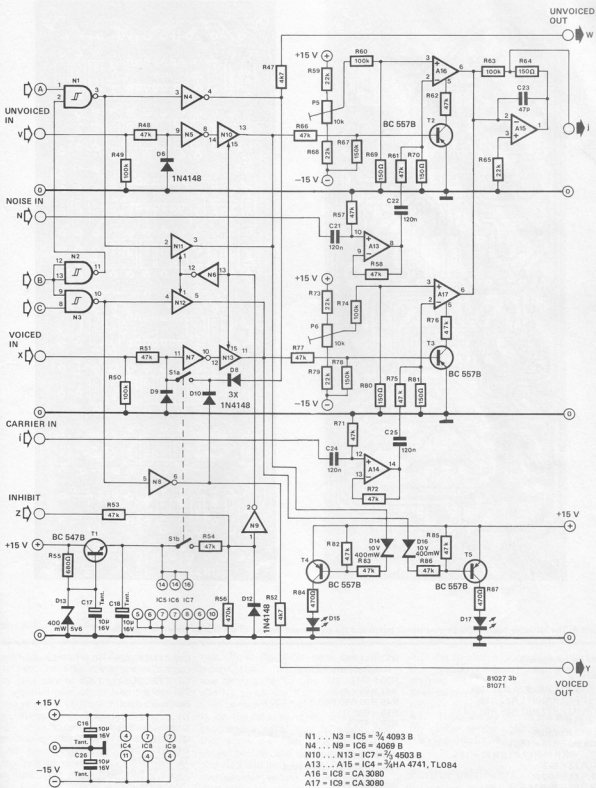

81027 3b
81071

- N1 ... N3 = IC5 = 1/4 4093 B
- N4 ... N9 = IC6 = 4069 B
- N10 ... N13 = IC7 = 1/2 4503 B
- A13 ... A15 = IC4 = 1/2 HA 4741, TL084
- A16 = IC8 = CA 3080
- A17 = IC9 = CA 3080

Figure 3. The full circuit diagram of the voiced/unvoiced detector. Roughly speaking, 3a constitutes the detection system and 3b the switch board.

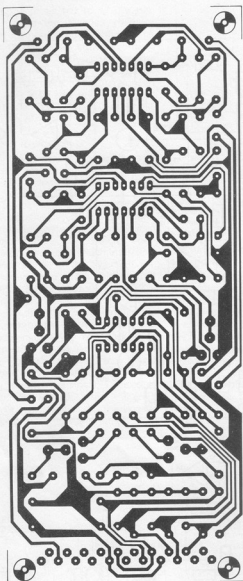

Figure 4. The 'detector board'. The printed circuit board and the component overlay of the section shown in figure 3a.

Parts list for figure 3

Resistors:

R1, R48, R51, R53, R54, R57, R58,
R61, R62, R66, R71, R72, R75,
R76, R77, R72, R83, R85, R86 = 47 k
R2 = 82 k
R3, R13, R14, R25,
R26, R67, R78 = 150 k
R4 . . . R9, R16, R17, R19, R20 = 15 k
R10, R22 = 2k2
R11, R23 = 100 Ω
R12, R18, R24, R34, R35 = 33 k
R15, R27 = 220 k
R21 = 27 k
R28, R29, R32,
R37 . . . R40, R43, R45, R46 = 10 k
R30, R41 = 1 k
R31, R42 = 39 k

R33, R44, R64, R69,
R70, R80, R81 = 150 Ω
R36 = 4M7
R47, R52 = 4k7
R49, R50, R60, R63, R74 = 100 k
R55 = 680 Ω
R56 = 470 k
R59, R65, R68, R73, R79 = 22 k
R84, R87 = 470 Ω
P1, P2 = 25 k preset pot.
P3 . . . P6 = 10 k preset pot.

Capacitors:

C1 = 680 n
C2 . . . C5 = 5n6
C6, C13 = 100 n
C7, C8 = 3n3
C9 . . . C12 = 12 n
C14, C15 = 39 n

C16, C17, C18, C26 = 10 μ /16 V tantalum
C19, C20 = 10 μ /16 V
C21, C22, C24, C25 = 120 n
C23 = 47 p

Semiconductors:

D1 . . . D12 = 1N4148
D13 = zener 5V6/400 mW
D14, D16 = zener 10 V/400 mW
D15, D17 = LED
T1 = BC 547B
T2 . . . T5 = BC 557B

IC1 . . . IC4 = HA 4741, TL 084
IC5 = 4093B
IC6 = 4069B
IC7 = 4503B
IC8, IC9 = CA 3080

Miscellaneous:

S1a/1b = double pole switch

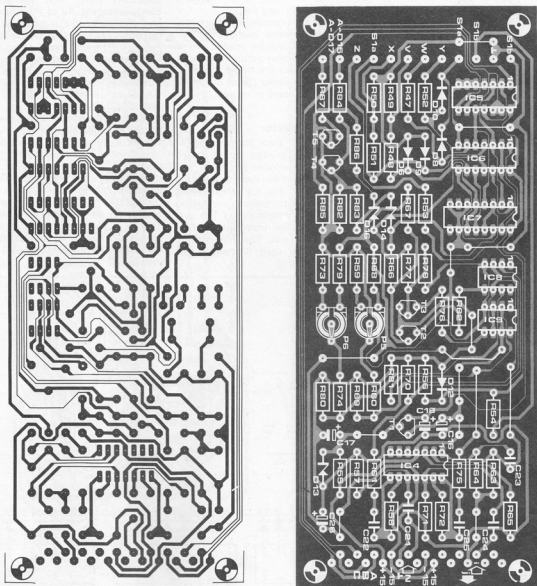

Figure 5. The 'switch board' contains the circuit in figure 3b.

lowed by a number of logic gates. All that need be said about these is that they take care of the trigger signals that are required later on to feed the carrier or noise signal to the synthesis filters at the right moment.

The 'voiced or unvoiced?' decision mentioned with regard to figure 2 is taken by comparators A10...A12. Supposing an unvoiced signal arrives at the input, the output of A10 will become high and that of A11 will be low. In other words, the output of gate N1 will be low, that of N4 will be high and that of N11 will be low as well. In the case, where the signal is unvoiced, the output from the low pass filter will either be zero or at least smaller than

that from the high pass filter. This means, the output of A11 will remain low causing that of gate N2 to be high and N1 to be low. The final verdict will then be: unvoiced.

If, on the other hand, the low pass filter produces a signal that is greater than that from the high pass, N1 will no longer be low and the outputs of A11 and A12 will both be high. The detector then decides: voiced.

The other tri-state gates (N10...N13) in figure 3b serve to switch off the detector if in the future it is to be controlled by means of a computer or microprocessor. The two LED indicators D15 (unvoiced) and D17 (voiced) display the state of the detector. Naturally,

if this is considered superfluous, the section around T4 and T5 can always be omitted.

The switch indicated in the diagram actually consists of two VCAs, A16 and A17. These ensure that in the end either the carrier or the noise signal is fed to the synthesis filters.

Further particulars

Preset pots P1 and P2 preset the switch to voiced or unvoiced, as required. This can be done by alternately uttering 'A' and 'S' sounds in the microphone. Depending on the results, the sensitivity can be readjusted if necessary. P3 and P4 preset the trigger point of the com-

parators A10 and A12. This must be done simultaneously with P1 and P2. Switch S1_{ab} acts as a select switch for the voiced state. It has been added to enable musical instruments to be used as modulators as well. Whenever music is entered at the speech input, closing S1 will prevent a sudden noise from being fed to the filters at every high tone. Whatever the signal, the detector will always decide it is voiced.

The inhibit input (Z) may be used to 'block' all the detector's decisions. Then of course the control inputs (V, X) must be provided with information. Again, this will come into effect once the unit can be controlled by a (micro)computer. OTAs A16 and A17 in the carrier/noise circuit need to be very carefully calibrated with the aid of P7 and P8. This must be achieved by a rectified signal at the control input (R66, R77). This method is spelled out in last year's March issue, vocoder constructors will no doubt remember the details. If the

unit is not properly calibrated irritating click sounds will be produced when the detector is switched, which happens regularly in speech and singing.

Figures 4 and 5 represent the track layout and component overlays of the voiced/unvoiced detector printed circuit boards. The detection circuit in figure 3a is incorporated on the board shown in figure 4, the remainder (figure 3b) being installed on the board in figure 5.

The noise generator

Figures 6 and 7 show the circuit diagram and the printed circuit board respectively of the noise generator. The noise generator is not only suitable for the vocoder but also for various other audio and acoustic measurements that demand a quality noise signal. The output can be switched from pink to white noise and vice versa. The unit consists of 7 commonly used ICs and a few passive components.

There is no need to describe its operation in full detail here, as various noise generators have been published in Elektor recently. All of them have their pros and cons and this particular design may be considered a combination of them with the addition of a zero inhibit. This concerns pseudo random noise which is generated with the aid of a 31 bit shift register (IC3... IC6). How this works was described in the January 1981 'Swinging Poster' article, where incidentally the same ICs were used.

N1 and N2 together form a clock generator at a frequency of about 500 Hz. About 70 minutes are needed to run through a 31 shift register in all its states at this clock frequency. This will make the noise sufficiently 'random'. Diodes D1... D31 combined with N3 provide the zero inhibit. As soon as the '000...0' state occurs, a '1' is entered in the shift register by way of N5. Gate N6 makes sure outputs 28 and 31 of the shift register are EXOR back coupled.

6

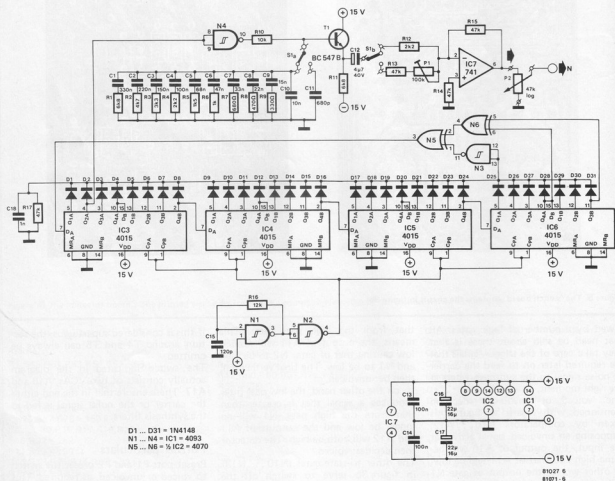

Figure 6. The noise generator. S1 selects either pink or white noise.

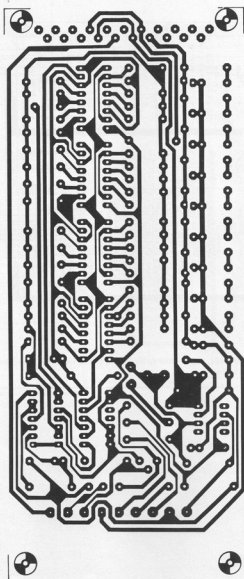

Figure 7. The noise generator boards. Its size is the same as the other vocoder boards and as the ones show in figure 4 and 5.

Parts list for figure 6

Resistors:

R1,R11 = 6k8
 R2 = 4k7
 R3 = 3k3
 R4,R12 = 2k2
 R5 = 1k5
 R6 = 1 k
 R7 = 680 Ω
 R8 = 470 Ω
 R9 = 330 Ω
 R10 = 10 k
 R13,R14,R15,R17 = 47 k
 R16 = 12 k

P1 = 100 k preset
 P2 = 47 k log.

Capacitors:

C1 = 330 n
 C2 = 220 n
 C3 = 150 n
 C4,C13,C14 = 100 n
 C5 = 68 n
 C6 = 47 n
 C7 = 33 n
 C8 = 22 n
 C9 = 15 n
 C10 = 10 n
 C11 = 680 p

C12 = 4μ7/40 V
 C15 = 120 p
 C16,C17 = 22 μ/16 V
 C18 = 1 n

Semiconductors:

D1 . . . D31 = 1N4148
 T1 = BC 547B
 IC1 = 4093
 IC2 = 4070
 IC3 . . . IC6 = 4015
 IC7 = 741

Miscellaneous:

S1 = double pole toggle switch

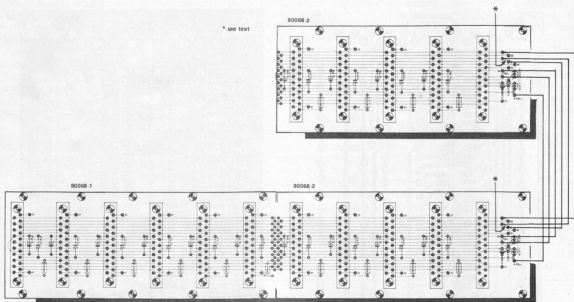
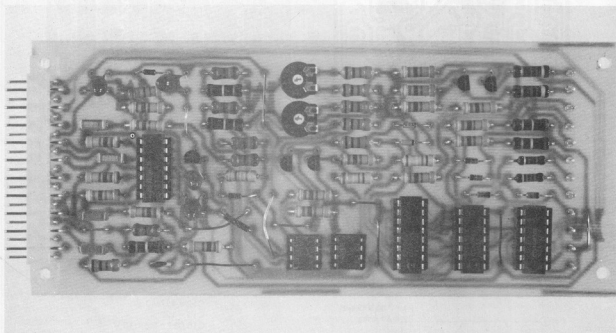

Figure 8. If an additional half bus board is used to connect the three expansion boards, it will have to be linked to the large bus board belonging to the vocoder. The copper tracks between points i-j have to be broken on both boards.



Buffer N4 is followed by a filter which can be switched to pink or white noise, whichever is required. The white noise filter is a low pass filter at 23 kHz with an edge of 6 dB per octave. IC7 acts to amplify the signal. The pink noise has to be slightly more amplified than the white, because its high frequencies have already been filtered out and so cannot contribute any further to it. P1 is used

to equalise the output voltages for pink and white noise.

The value indicated for the supply is based on that of the vocoder (± 15 V). However, the noise generator will work equally well at ± 12 V.

The connections

We are left with three new boards that have to be connected to the existing

vocoder. From the block diagram in figure 1 it can be seen what the procedure basically involves. There are two possibilities:

1. Take an additional 'half bus board' (EPS 80068-2). The three new boards are exactly the same size as the other vocoder boards and can all be provided with a similar connector. If a connector is mounted on all three, they can be

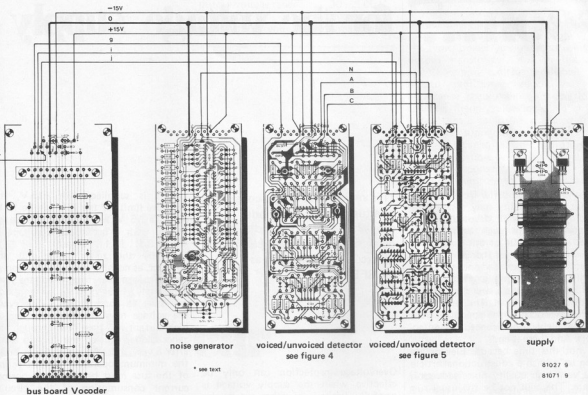

Figure 9. The expansion boards may also be connected without an additional half bus board, although wiring is a little more complicated. Here again, the i-j connection on the bus board (left) will have to be broken.

inserted into the bus board straight away and this will then take care of the individual connections. That's all there is to it. The supply voltage(s) and points i, j and g obviously have to be derived from the vocoder bus board. How this is done is shown in figure 8. At the same time the additional half bus board provides a simple connection for the existing supply board belonging to the vocoder. This is an advantage, as there was no room for this on the original bus board. Now the supply board may be inserted into the additional half bus board and the connections remain as indicated in figure 8.

Two more remarks: As illustrated in figure 1, the existing connection between points i and j in the vocoder will have to be interrupted when the voiced/unvoiced detector is connected. The i-j connections will therefore have to be broken both on the 'old' and on the 'new' bus board.

Finally, to avoid any misunderstanding: for the drawing of the connections in figure 8 the circuit board drawings of the old bus board were used. Be careful *not* to mount any components on the new half bus board, in spite of the indications in figure 8.

2. Don't use an additional half bus board — make the connections yourself. This will be necessary if the case is not wide enough for another three connecting boards so that the expansion boards will have to be mounted elsewhere in the case. The wiring required is shown in the diagram in figure 9. Again, of course, the i-j connection on the bus board will have to be broken.

Final notes

The 'computer' connections indicated in the diagram as: unvoiced in (V), unvoiced out (W), voiced in (X), voiced out (Y) and inhibit (Z) are all situated on the front of the 'switch boards' given in figure 5. If required, these points can be led out quite simply with a connector. This will enable experimenters to control the unit by means of a computer without having to cope with complicated wiring problems.

As the connection diagrams of figures 8 and 9 show, both the voiced/unvoiced detector and the noise generator can derive their supply voltage from the existing vocoder power supply. The current consumption of the three

expansion boards adds up to about 100 mA for the +15 V voltage and to about 50 mA for the -15 V. Since the vocoder was issued with a 400 mA transformer, the extra consumption will by no means overload the circuit.

People have told us that the -15 V section of the original vocoder supply may encounter stability difficulties. This can be remedied by substituting C83 for a $2\mu\text{F}/25\text{V}$ tantalum electrolytic capacitor and C85 for a $1\mu\text{F}/25\text{V}$ type.

coming soon...

emergency brake for the voltage supply

Those readers who suffer from a critical ear for sound quality may cast a jaundiced eye at an article devoted to noise reduction systems such as that presented on page 2.04 of this issue. They may be forgiven for considering the subject to be rather academic since it is usually the case that a great deal of information and data are discussed at length but to no avail. The same problem always occurs, the special ICs are only available to licenced manufacturers. And there it ends!

But not this time because Elektor are going to publish a constructional article on a very high quality noise reduction system. This will not be the usual run of the mill opamp circuit but an Elektor designed and tested system featuring the well known High-Com IC from Telefunken. What is more, we will also supply the IC together with the printed circuit boards, to provide the sort of high quality project that readers have come to expect from Elektor. To top it all, the whole system has been tested and approved by Telefunken.

... and it will not cost the earth to build either.

This very simple circuit consisting of a fuse and a zener diode provides a useful method to avoid damage to components sensitive to excess voltages, such as MOSFET IC's.

Overvoltage protection can only be effective when the supply voltage is carefully limited, in other words, by including a voltage control system. Even so, this still does not prevent the output voltage from being able to rise above the preset value. Even electronic voltage controllers, whether they be discrete or integrated, can fail. Although the power supply usually suffers very little damage, the circuit itself is often considerably damaged. Brief voltage peaks in the supply as well as complete power failure can also write off expensive IC's. Prevention being better than cure, or in this case, repair it is worthwhile to include a fuse and a zener diode at the output of the power supply, as shown in figure 1.

1

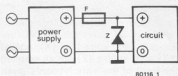

circuit is supplied with +15V, the absolute limit for the IC's will be 18V. Thus, a 16V zener diode will be included with a break down voltage in the 15.3...17.1V range.

Normally the zener diode will not conduct, as nothing is wrong. As soon as the output power supply voltage rises excessively, however, the zener diode will start to conduct and will prevent the voltage from rising any further. A high current will then flow through the zener diode, causing the fuse to blow after a very short period of time. Thus, the minimum operating current rating of the fuse must be above the normal current consumption of the circuit. The zener diode must be able to resist this short burst of high current. The zener diode should be cooled for improved thermic resistance. At the same time, the fuse will also protect the circuit from 'shorts'. The zener diode will then add to the protection by limiting the voltage to about 0.7V when the supply is incorrectly polarized.

2

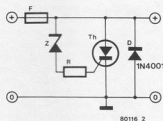

If the fuse operates at a fairly high minimum current rating, a corresponding power zener diode will cost quite a bit of money. A more economical solution is to control the fuse via a thyristor, as shown in figure 2. As soon as the supply voltage reaches the critical level, the zener diode in the gate of the thyristor will conduct, the thyristor will switch on and blow the fuse. Resistor R at the thyristor gate limits the gate current and also the zener current through the diode.

HIGH COM

TFK 34
U401 BR

AN ELEKTOR EXCLUSIVE
DONT MISS IT.

This 'emergency brake' works simply yet effectively. The zener voltage of the diode is chosen at a level 2V higher than the output voltage of the power supply, although this must of course be below the upper threshold of the supply voltage (absolute limit) which the components in the circuit can endure. If, for example, a CMOS

Specification

maximum output power	150 W
output voltage range	30 ... 60 V
efficiency	approximately 60%
quiescent current	800 mA maximum

150W DC to DC converter for the car

Readers who consider that the power output and performance of their car stereo equipment is rather on the low side, in spite of the 15 W that the normal booster will provide, are now able to "drive" a high power Hi-fi output stage by incorporating the DC to DC converter described here.

high power Hi-fi

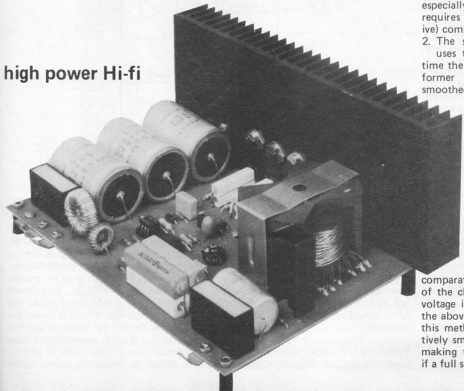

Run-of-the-mill car radios and cassette players rarely boast an audio power output of more than 3 ... 6 watts. For this reason many people look for improvement, such as combining two 4 W output stages to form a 15 W bridge amplifier. Unfortunately, that is just about the limit, unless you resort to using an output transformer, due to the low (12 V) supply voltage available. An output transformer reduces the load impedance requirements for the loudspeaker, thereby allowing a higher AF output than could be expected from the power supply alone. The main problem is, of course, that transformers cause distortion and reduce the frequency response. Apart from that, suitable transformers are not really readily available for the amateur constructor.

What is the alternative? Low cost ICE (In Car Entertainment) amplifiers or boosters seldom exceed the 15 W threshold, and they can hardly be classified as Hi-fi equipment. Obviously, quality high power amplifiers do exist, but the price is something else! This article describes a unit which will increase the available voltage from 12 V to the level required by powerful Hi-fi output stages.

Converter

Basically, there are three types of converters:

1. Conversion by 'chopping' the DC input voltage and then multiplying the AC waveform produced via a network of capacitors and diodes (see figure 1). Technically, this is a very elegant solution and one which requires very little space. However, the principle, especially where high power is involved, requires the use of high quality (expensive) components.

2. The second type of converter also uses the chopping method, but this time the AC waveform is fed to a transformer before being rectified and smoothed (see figure 2). By using a transformer the voltage can be stepped up (or down) to virtually any desired level, however, the higher the voltage, the less current available.

3. The third method constitutes a compromise between the two with respect to the value of inductance required. Here, the DC input voltage is again chopped before being rectified and smoothed, but this time the output level is monitored and compared with a reference level. In turn, the comparator controls the switching speed of the chopper so that a steady output voltage is maintained. The principle of the above is shown in figure 3. By using this method the circuit requires a relatively small coil with few turns thereby making the device more compact than if a full sized transformer were used.

Circuit

The complete diagram of the DC to DC converter is given in figure 4. The control circuit consists of a reference voltage source (R4, D1 and C3), a comparator (opamp IC1) and a 555 timer (IC2) connected as an astable multi-vibrator (or, more accurately in this instance, as a pulse generator). Transistors T3...T5 (connected in parallel) form the electronic switch shown in the block diagram (figure 3).

The output signal from the pulse generator is (current) amplified by transistor T2 to drive the three switching transistors. Inductor L1 acts as a voltage conversion coil. Components D3, C8...C11 and L3 have been included to rectify and smooth the output voltage.

The comparator (IC1) compares the output voltage of the converter via P1, R2 and R3, to that of the reference voltage across D1. If the voltage at the inverting input of the comparator is lower than at the non-inverting input, the comparator output voltage will be high. This then enables the pulse generator which produces a series of negative-going pulses until the output voltage of the converter corresponds to the value preset with potentiometer P1. As soon as this is the case, the output of the comparator will go low and the pulse generator will be inhibited. The output level of IC2 will then remain high, so that transistors T2...T5 will no longer conduct. This ensures that the conversion efficiency and quiescent current figures take on acceptable values.

Transistor T2 amplifies the output pulse current to about 1.5 A. This means that as transistors T3...T5 are overdriven by this base drive current, superfluous charge carriers arise in their bases which would prevent the transistors from turning off fast enough. Normally, when inductive loads are switched at high frequencies a large amount of energy would be dissipated. For these reasons, components R12, L2 and D2 are included in this section of the circuit to speed up the transfer of charge carriers. The voltage rise at the collectors of the switching transistors is slowed down to a certain degree by D4 and C7. During the final phase, capacitor C7 discharges through R22.

When the three transistors are turned on, the current flowing through the coil (L1) produces a magnetic field. When the transistors are turned off, this magnetic energy is re-converted to electrical energy by means of the back emf generated in the coil. The voltage at the anode of D3 will therefore rise rapidly until it becomes slightly greater than that of the reservoir capacitors C8, C9 and C10. The D3 will conduct and the capacitors will be "topped up". Three reservoir capacitors are used, instead of the usual one, so that a large capacitance can be obtained from relatively small (dimension-wise) capacitors. This ena-

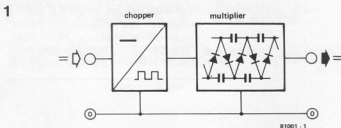

Figure 1. DC to DC conversion by chopping the input voltage and multiplying the AC signal thus obtained via a network of diodes and capacitors.

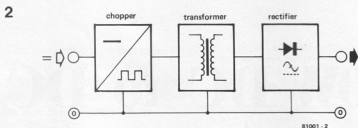

Figure 2. DC to DC conversion by stepping up the chopped signal via a transformer prior to rectification and smoothing.

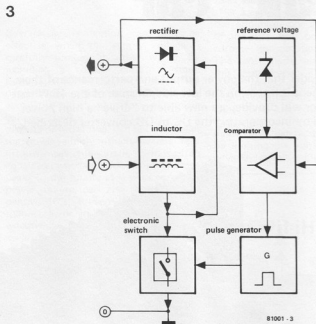

Figure 3. DC to DC conversion where the output voltage is compared to a reference voltage to determine the pulse repetition of the chopper.

bles the reservoir capacitors to be mounted on the printed circuit board. The low pass filter L3/C11 ensures that any high frequency noise is eliminated from the DC output voltage. Which is just as well, as this could influence the AF amplifier connected to the converter.

Selecting the components

Since the DC to DC converter needs

to be capable of delivering up to 150 W, either large inductors or high switching frequencies will have to be employed. As the output voltage is to be greater than the input voltage, very short switching times will be required. In this particular instance, a compromise between the size of the inductor and the availability of HF components was sought.

The switching frequency is no higher

than 40 kHz and the duration of each pulse is approximately 10 μ s. These two parameters are determined by the values of R5, R6 and C4. As the pulse length is relatively short and the repetition rate relatively fast, the switching transistors will have to be quality devices — the ubiquitous and universal 2N3055 just doesn't come up to spec! Slightly more expensive, but not too difficult to obtain, are the BD240B and BD245B types. Other transistors with a similar specification to that shown below can, of course, be used instead: $V_{CE0} = 80$ V, $f_T = 3$ MHz, $t_{off} = 300$ ns.

Three parallel connected output transistors are incorporated to cope with the high peak current produced. Diode D3 must be a fast recovery type such as the BYX371/600 (or equivalent).

Inductors

Coil L1 is made up from a ferrite pot core with the following dimensions:

diameter = 50 ... 70 mm;
height = 30 ... 40 mm.

The core must be capable of operating to frequencies of 100 kHz. The number of turns around the core depends on the value of inductance required and the so-called A_L value of the core (expressed in nano-henries). The required inductance for L1 was calculated to be 144 μ H. Therefore the number of turns required will be

$$n = \sqrt{\frac{L}{A_L}}$$

The cores indicated in the parts list have A_L values of either 1000 or

630 nH. In other words, the number of turns required will be

$$n_{1000} = \sqrt{\frac{144 \times 10^{-6}}{1000 \times 10^{-9}}} = 12 \quad \text{or}$$

$$n_{630} = \sqrt{\frac{144 \times 10^{-6}}{630 \times 10^{-9}}} = 15$$

Since high currents are involved, and to ensure that the circuit operates efficiently, the diameter of the wire used needs to be fairly large. However, when high frequencies are being employed, the 'skin effect' becomes most disturbing, therefore, it is far better to wind several thinner wires around the core. Thus:

— core with A_L of 1000 nH:

12 turns of five 1 mm diameter enamelled copper wires in parallel

— core with A_L of 630 nH:

15 turns of five 1 mm diameter enamelled copper wires in parallel

If wires of different diameters are used, the number of turns will have to be calculated accordingly.

Pot cores without an air gap have much greater A_L values, therefore the results from the above calculations will no longer be applicable. However, an air gap can be introduced by inserting a cardboard disc between the two halves of the pot core. Unfortunately, this does mean that the pot core can not be mounted on the printed circuit board with a single (central) screw. The size of the air gap determines the efficiency of the circuit. To obtain the optimum efficiency level, various thicknesses of cardboard should be tried until the quiescent current is down to a minimum

(no load).

Inductors L2 and L3 are ring core interference suppression inductors as used in thyristor and triac control circuits. The former is a 2 A type and the latter a 6 A type.

Construction

The entire circuit can be mounted on the printed circuit board shown in figure 5. The two halves of the pot core should be glued together to prevent the coil from 'whistling'. The output transistors, T3 ... T5, and the fast recovery diode, D3, can all be mounted on the same heatsink (2° C/W or greater). Mica washers and a layer of heat conducting paste should be used when installing the power transistors and the diode. In the prototype unit the heatsink was mounted vertically on the board (200 mm wide by 75 mm high) and therefore doubled as the rear panel of the case. A metal case is an absolute must in this instance as without one the converter would radiate interference signals throughout the entire long and medium wavebands. Not only will the Post Office object to this, but also it will be virtually impossible to receive any broadcasts on a radio powered by the converter. Transistor T2 also requires a small heatsink.

Heavy gauge wire (at least 2.5 mm² diameter) must be used to connect the DC to DC converter to the car battery and to the load. The leads can be soldered directly to the printed circuit board, but some provision for retention must be made to avoid damage to the actual

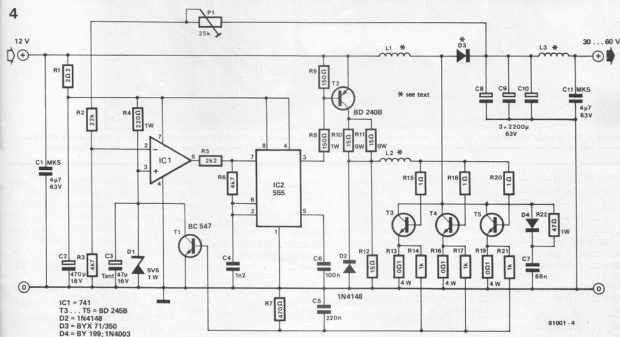

IC1 = 741
T3 ... T5 = BD 245B
D2 = 1N4148
D3 = BYX 71/350
D4 = BY 199; 1N4003

81001 - 4

Figure 4. The complete circuit of the DC to DC converter. Inductor L1 is made from a pot core which has an air gap (see text for winding details). Inductors L2 and L3 are 2 A and 6 A interference suppressors as used in thyristor and triac control circuits.

5

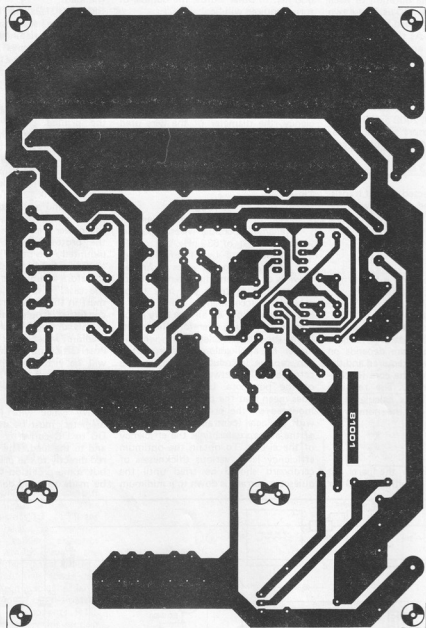

Figure 5. The printed circuit board and component overlay for the DC to DC converter. All of the components including the heatsink for the power transistors can be mounted on this board. The completed board should be installed in a metal case to reduce radiation interference.

Parts list

Resistors:

R1 = 2Ω
 R2 = 22 k
 R3, R6 = 4k7
 R4 = $220\Omega/1\text{ W}$
 R5 = 2k2
 R7 = 470 Ω
 R14, R17, R21 = 1 k
 R8 = $150\Omega/1\text{ W}$
 R9 = 150 Ω
 R10, R11 = $15\Omega/9\text{ W}$
 R12 = 15 Ω
 R13, R16, R19 = $0,1\Omega/4\text{ W}$
 R15, R18, R20 = 1 Ω
 R22 = $47\Omega/1\text{ W}$
 P1 = 25 k preset

Capacitors:

C1, C11 = $4\mu\text{F}/63\text{ V MKS}$
 C2 = $470\mu/16\text{ V}$
 C3 = $47\mu/16\text{ V tantalum}$
 C4 = 1n2
 C5 = 220 n
 C6 = 100 n MKS
 C7 = 68 n MKS
 C8, C9, C10 = $2200\mu/63\text{ V}$

Inductors:

L1 = Ferrite pot core
 Siemens B65694-A1000-A027
 + bobbin
 B65695-B1000-T001 + mounting
 B65695-A2000-X000
 + 15 m CuL ϕ 1 mm
 or
 Siemens B65644-A0630-A027
 + bobbin
 B65645-B1000-T001 + mounting
 B65645-A2000-X000 + 10 m
 CuL ϕ 1 mm. (Electrovalve)
 L2 = 2 A interference
 suppressor (T. Powell)
 L3 = 6 A interference
 suppressor (T. Powell)

Semiconductors:

D1 = 5V6/1 W zenerdiode
 D2 = 1N4148
 D3 = BYX71/600 (RS components)
 D4 = BY 199, 1N4003
 T1 = BC 547
 T2 = BD 240B
 IC1 = 741
 IC2 = 555

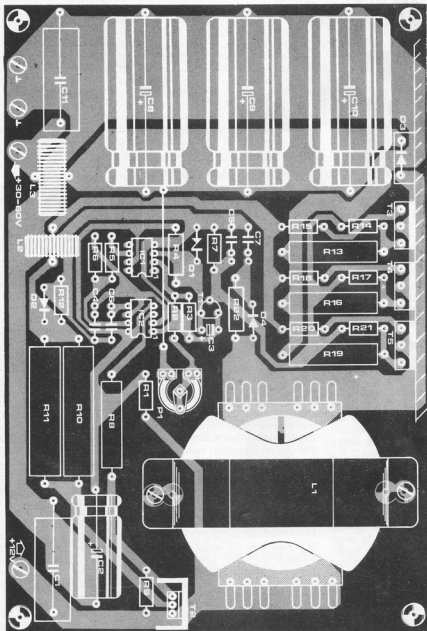

board. This can be achieved by utilising 'P' clips or rubber grommets (or both). If desired, standard ¼" 'blade' connectors can be used to facilitate construction and installation. In addition, the unit requires an on/off switch and a 30 A fuse must be included in the 'live' battery lead.

Operation

Once construction has been completed, the circuit can be connected to a 12 V DC power supply having an output current capacity of around 2...3 A. A multimeter switched to the 10 A range is connected in series with the positive supply lead. With no load connected, a large amount of current will

flow initially until the capacitors in the unit become fully charged. After a short period of time, the quiescent current should drop to about 50...800 mA, depending on the preset output voltage. The required output voltage can then be selected, between 30...60 V, by adjusting preset potentiometer P1. When a load is connected to the converter it should be possible to hear the change in pulse repetition frequency from one (or more) of the coils.

Uses

This multi-purpose circuit is ideal for powering two 40 W Edwin amplifiers

driven from the car stereo system. It is also possible to install a low voltage temperature controlled soldering iron into the car (provided, of course, that it is a DC model). Linear amplifiers and other ham radio equipment (and shortly CB?) requiring more than 12 V can also be connected to the converter. ■

Note: The output voltage can be reduced by decreasing the value of R2. If the converter only needs to supply 50 W, the following components can be omitted: R11, R16...R21, C10, T4 and T5; the value of R7 must then be increased to 1k5.

low noise 2 metre preamplifier

This preamplifier is intended for use in receivers of the 2 metre amateur band wave (144 MHz). By changing a single resistor, it can be made for either very low noise or a low intermodulation distortion.

Internal noise

This low noise VHF preamplifier operates with a particular type of extremely low noise, high frequency transistor, the BFT 66. This transistor ensures that the noise contribution of the amplifier stage thus obtained is small, for usually the lion share of noise produced is caused by the transistor.

The noise contribution of an amplifier is rather an abstract concept and it is not the purpose of this article to define it. However, it will be clear that even this can be expressed as a factor: the noise factor. Basically, this indicates the relationship between the quantity of noise present in the output signal of an amplifier and the quantity of noise which it would contain if the amplifier would merely amplify without adding to the noise itself. Usually this ratio is expressed in dB.

An amplifier which produces no internal noise at all has a noise factor of 0 dB. The output signal will then contain exactly (relatively speaking) the same amount of noise as the input signal. Such amplifiers unfortunately do not exist, although there are a few which come near to meeting this figure.

The amplifier described here has a noise factor of less than 1 dB, which means the signal to noise ratio only deteriorates by 1 dB. For a VHF preamplifier this is an excellent performance.

The circuit diagram

The circuit diagram of the 2 metre preamplifier is not nearly as complicated as most circuits of this nature. It is possible to connect a normal 50 ohm aerial to the input. However, since the impedance of the aerial often deviates from that required for an optimum noise factor at the base of the transistor, the aerial cannot be directly connected to the base. For this reason a pi network is placed between the base of T1 and the aerial input. This consists of trimmers C1 and C2 and the coil L1. The pi network literally matches the impedances.

In the collector lead of T1 there is a resonance network consisting of L and

C4. The ferrite band FB is included to prevent oscillation. In many cases it may not be necessary. An alternative is to replace it with a 15 Ω resistor.

The collector current of the transistor will be the main determining factor in the noise contribution of the amplifier. The preset P1 is used to adjust this. With the component values given in the figure, the collector current may be preset to 3 mA since at this figure the BFT 66 gives its best noise performance. The collector current can very easily be determined by measuring the total current consumed by the circuit, or the voltage across R3.

With a collector current of 3 mA, the internal noise contribution of the amplifier will be less than 1 dB. To give some idea this means that in a receiver bandwidth of 3 kHz, an input signal of only 25.6 nV (0.025 μ V) will already produce an output signal that can be detected. The 3 dB bandwidth is 5 MHz.

Intermodulation distortion

It is clear that the collector current has a great influence on internal noise. However, something else is also highly dependent on the collector current, namely, intermodulation distortion.

This is the creation of all kinds of by-products in the output signal which were not in the input signal. The reason for this is that the transistor is not linear.

The intermodulation distortion can also be expressed in dB, as the ratio between the desired signal and the intermodulation products. For obvious reasons, this ratio should be as high as possible. In other words, an ideal amplifier would have virtually no intermodulation distortion coupled with an extremely low noise factor. It would be ideal if the collector current producing the lowest possible noise could at the same time ensure the lowest possible intermodulation distortion. This however is wishful thinking.

From the noise point of view the ideal collector current would be 3 mA. However, this would produce intermodulation products of only 10 dB (for 800 MHz admittedly). By increasing the collector current to 10 mA, the intermodulation can be reduced to -60 dB — a considerable improvement. The price that has to be paid for this is an increase in the noise factor by approximately 0.5 dB.

Depending on what you want, the amplifier can be tailored quite simply. A collector current of 3 mA will give a low noise amplifier. Taking the current up to about 10 mA and changing the value of R3 to 330 Ω will produce an amplifier with very little intermodulation distortion.

Constructional details

It is advisable to use low noise metal foil resistors for R1 and R2. Both the coils L1 and L2 are 'air cored', that is, wound on an 8 mm diameter former which is then removed. The 1 mm copper wire used for the coils should be silver plated. The winding details are x =, for L1 6 turns, and for L2 4 turns with taps at the first and second turns as shown in the diagram.

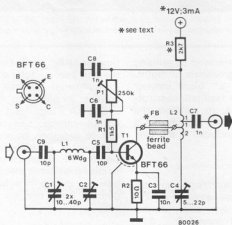

With this simple circuit low noise or low intermodulation distortion is possible.

Building a digital voltmeter is so simple nowadays that there is really nothing to it. All it takes are a couple of ICs which incorporate the entire circuit: A/D converter, counter and display control, so that a display will usually be enough to complete the job. The advantages speak for themselves: the circuit is easy to build, requires little calibrating and is fairly accurate. Unfortunately, however, all this is outweighed by one major disadvantage - try obtaining the prescribed ICs at your local dealer's and you'll find he won't have them in stock. In other words, the hobbyist ends up not constructing a voltmeter at all.

To make it more worthwhile, our designers racked their brains to come up with a solution using 'ordinary' parts. The result? A 2½ digit voltmeter with a very reasonable accuracy of $\pm 0.5\%$. It is sufficiently accurate for all the normal chores, especially considering that the accuracy of a decent analogue multimeter amounts to several percents.

2½ digit DVM

Three displays, six ICs and a handfull of components are the only ingredients needed to cook up this digital voltmeter. No attempt has been made this time to produce an exotic recipe using rare ICs and extreme accuracy, but a plain, simple voltmeter including readily available components.

An interesting circuit

Figure 1 shows the diagram of the DVM. Most of the work is done by IC1, a kind of jack-of-all-trades where controlling displays is concerned. This CMOS IC contains a number of items, a 4 digit counter, a latch, a seven segment display control and a multiplex circuit. In this particular circuit only three of the four displays that could be connected to it are used. The multiplex outputs A, B and C switch the display common cathodes by way of transistors T1, T2 and T3.

A falling edge at the latch input shifts the contents of the counter to a slave flip-flop. A logic one at the reset input resets the counter. The contents of the slave flip-flop can be seen on the displays.

The latch and reset signals are provided by IC5, N1 and N2 and their corresponding components. IC5 is connected as an astable multivibrator with a fairly large pulse to interval ratio having a frequency of about 2 Hz. With the aid of C6, R17, C7 and R18 gates N1 and N2 derive two pulses for the reset and latch control from the multivibrator. Since the reset pulse arrives a little

later than its latch counterpart, first the contents of the counter are shifted to the slave flip-flop and then the counter is reset. The number of pulses entering via the clock input of IC1 during the interval between the reset and latch signals is therefore shown on the display.

Use has been made of a voltage to current converter to convert the voltage measured into a frequency. At the same time this determines the time constant of the multivibrator and consists of a voltage controlled current source.

The voltage to be measured is now connected between the supply of the current source (6.8 V) and the non-inverting input of IC3. IC3 then regulates its output voltage in such a way, that T6 conducts until the voltage of the inverting input is practically the same as that at the non-inverting input. This means the voltage across R12 and P2 is equal to the voltage that is to be measured. Thus, the current passing through P2 and R12 is equal to the test voltage. This current is derived from the collector of T6. Its level determines the charge time of capacitor C9. The multivibrator constructed with IC4 is arranged so that C9 will be discharged whenever its voltage is equal to half the supply voltage (in this case the stabilised 5 V). In other words, when the input voltage is high, capacitor C9 will charge and discharge very quickly, as a result of which IC4 will generate a high frequency to the clock input of IC1. The final outcome is a large figure on the display.

The charge current of the capacitor is equal to $\frac{U_{in}}{P2 + R12}$, so that the meter

can be calibrated with potentiometer P2. P1 takes care of the zero setting. Diode D1 serves to protect the input against voltages with the wrong polarity. There is also a circuit that protects against excess input voltages in the diagram, even though this is difficult to see. The DC at the cathode of D2 is maintained at 3.9 V by R11 and D3. The supply for the current source is also at the \oplus input and is 6.8 V. If the input voltage is higher than the difference between two zener voltages plus the threshold voltage of diode D2 ($6.8 - 3.9 + 0.6 = 3.5$ V) D2 will conduct and the remaining voltage will be dropped across R10. This helps protect the circuit against input voltages of up to 100 V.

The supply of IC3 has been deliberately chosen at a higher level than that of the current source, because when the input voltage is 0 V the output voltage of the opamp should be $6.8 - U_{BE}$. This would not be possible if the supply of the opamp were also 6.8 V.

In addition, high voltages can be indicated on the display. IC1 has a carry output which generates a pulse whenever the maximum level of the counter is exceeded (read-out 199). By way of

1

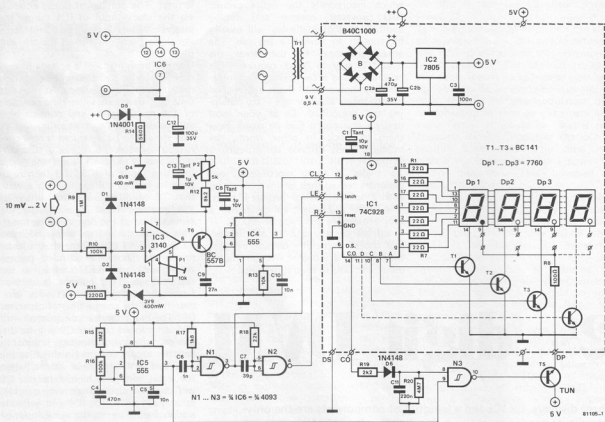

Figure 1. The DVM circuit diagram. The dotted area is incorporated on the universal display board and the rest on the DVM board.

a peak detector (R19, D6, C11 and R20) this pulse is detected causing N3 to flash the point of Dp1 via T5 at the frequency of IC5.

Finally, it should be noted that the Dp1 readout is suppressed whenever the input voltage is 0.99 V or smaller.

The supply for the circuit (apart from the current source) is provided by an integrated voltage regulator 7805.

Construcion

All the parts involved in building the DVM are mounted on the two printed circuit boards shown in figure 2. The dotted area in the diagram given in figure 1 is mounted on the display board. This section happens to be universal and therefore suitable for various circuits. Although four displays and four control transistors are shown, the DVM only requires the first three displays and transistors. The decimal points all have external connections so that they can be converted if the meter is to be used in various measurement ranges. For the standard range (10 mV ... 2 V) the point of Dp1 is connected to resistor R8.

2

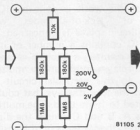

Figure 2. This resistor divider enables the number of measurement ranges to be extended. In this case, resistor R9 may be omitted.

The input circuit and the oscillators are incorporated on the second board. The unit allows the two boards to be placed one behind the other after which the corresponding points are connected by wire links. The only component left to be added is the transformer as this is not included on the board.

Using the resistor divider illustrated in

figure 2 the meter can be provided with several ranges. R9 can then be omitted. Make sure neither input is connected to the ground of the supply.

Calibration

As mentioned earlier, the DVM ranges from 10 mV to 2 V. Its accuracy will then be at $\pm 0.5\%$. To start with, the input is 'shorted'. Then the wiper of P1 is turned towards pin 5 of IC3 (anti-clockwise) slowly until .00 appears on the display.

Now the input may be re-connected and the meter can be calibrated. A reference voltage is fed to the input and the meter is calibrated with P2. Usually, however, there will be no accurate, known voltage available. The simplest thing to do is to compare the result with that of another meter, an accurate one, at an input voltage of about 1 V. Whether or not the meter has been correctly calibrated will then depend on the quality of the other one used.

If the meter has the resistor divider shown in figure 3 added to it, the accuracy in the other ranges will of course depend on the resistors used.

3

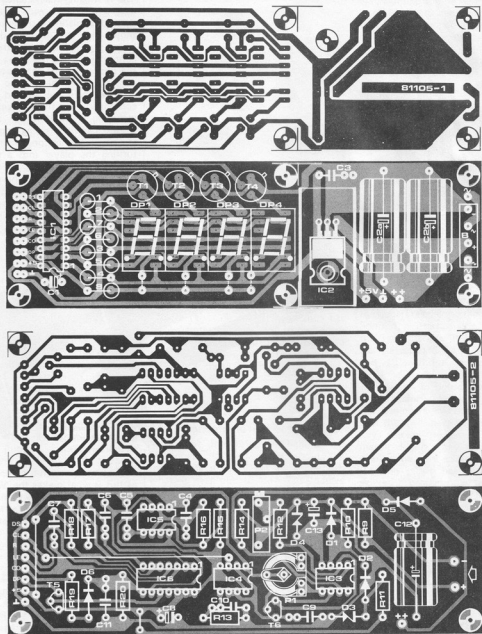

Figure 3. The circuit and component overlay of the two DVM boards. The corresponding points indicated on the two boards have to be connected. An additional fourth display and a transistor are also shown, but these are not used in the DVM.

Parts list

Resistors:

R1 ... R7 = 22 Ω
 R8 = 100 Ω
 R9 = 1 M
 R10, R16 = 100 k
 R11 = 220 Ω
 R12 = 8k2
 R13 = 10 k
 R14 = 560 Ω
 R15 = 1M2
 R17 = 1k8
 R18 = 22 k
 R19 = 2k2
 R20 = 4M7
 P1 = 10 k preset pot
 P2 = 5 k multi-turn pot

Capacitors:

C1 = 10 μ /10 V tantalum
 C2a, C2b = 470 μ /35 V
 C3 = 100 n
 C4 = 470 n
 C5, C10 = 10 n
 C6 = 1 n
 C7 = 39 p
 C8 = 1 μ /10 V tantalum
 C9 = 27 n
 C11 = 220 n
 C12 = 100 μ /35 V
 C13 = 1 μ /10 V tantalum

Semiconductors:

T1 ... T3 = BC 141
 T4 not required

T5 = TUN

T6 = BC 557B
 IC1 = 74C928
 IC2 = 7805
 IC3 = 3140
 IC4, IC5 = 555
 IC6 = 4093
 D1, D2, D6 = 1N4148
 D3 = 3V9/400 mW zener diode
 D4 = 6V8/400 mW zener diode
 D5 = 1N4001
 B = B40C1000

Miscellaneous:

Dp1 ... Dp3 = 7760
 Dp4 not required
 Tr1 = mains transformer 9 V/0.5 A

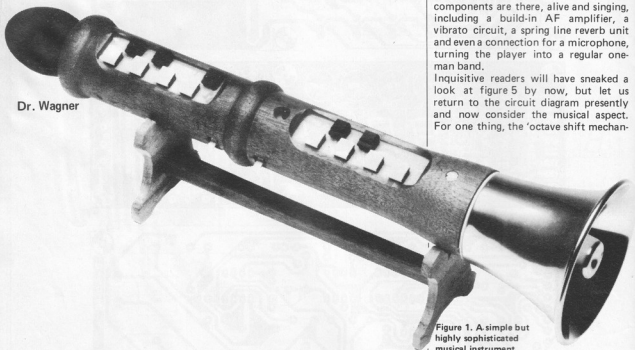

Dr. Wagner

The first thing that catches the eye is of course the instrument's shape. Hardly that of a piano or organ! The version shown in the photograph certainly looks sophisticated but the electronic contents are not nearly as elaborate as the appearance of the prototype might suggest. Nevertheless, no short cuts were taken in the lab and all the vital components are there, alive and singing, including a build-in AF amplifier, a vibrato circuit, a spring line reverb unit and even a connection for a microphone, turning the player into a regular one-man band.

Inquisitive readers will have sneaked a look at figure 5 by now, but let us return to the circuit diagram presently and now consider the musical aspect. For one thing, the 'octave shift mechan-

Figure 1. A simple but highly sophisticated musical instrument.

the wagnephone

A mini keyboard with an 'octave shift mechanism'.

This ingenious little instrument will save worn-out fingers and relegate years of tedious practice to the dim past. As can be seen from the photo, it includes a microphone for vocal accompaniment and a unique 'octave shift mechanism' which moves the notes up or down an octave without stretching the player.

ism' alone is worth a closer inspection, as this is what makes the 'Wagnephone' so much easier to play than an ordinary keyboard instrument. In fact, it cuts the average learning time required by more than half.

Scales that tip the scales

There's no doubt about it, the world would be a boring place to live in without any music to liven it up. Thousands would love to be able to play the piano or the organ, but are deterred by the great difficulties involved in learning how. If only it were easier . . .

Looking at a 'normal' keyboard, any short cuts around the problem seem to be out of the question. To start with, so much fingering is entailed! The fingers are worked to the bone, as they not only have to strike the keys in a vertical movement of the hands, but they also have to move horizontally, up and down the keyboard, in order to find the right notes . . . and often at a cracking pace!

People who have tried sitting in front of a keyboard and striking a note while keeping one eye on the manuscript know that this takes years of practice. After all, what it scales down to, is teaching the fingers to build up a complicated system of reflexes, so that,

eventually, they can pick out a tiny white or black target from the total length of the piano and 'hit' it without exceeding the 1% tolerance limit. Every wrong note jars the ear instantly, so there are no second chances here.

Playing slowly requires a certain amount of effort as it is, playing at high speed with the feet is a feat indeed... Jokes aside, the technique and patience involved in playing a simple piece are such, that it's hardly surprising most people will think twice before even trying.

Fingering on a small scale

Now that we've scared the daylight out of any would-be pianist — yes, there is an easier way to learn thanks to the Wagnephone. The instrument in the photograph closely resembles a recorder, even though it has a keyboard. Why? Because a recorder happens to be relatively easy to play. The time to master the art takes somewhere between $\frac{1}{2}$ and $\frac{1}{10}$ of that on the piano or organ. The big difference between the two types of instruments is that the recorder involves fewer movements (of the hands, not the music!). The fingers cover a row of holes and remain fairly stationary, except that they have to be lifted every now and then. To be fair, the breathing technique is a different story, especially when an octave has to be jumped. However, this is irrelevant here, as in spite of its shape the Wagnephone is not a wind instrument.

Avoiding the key-search problem altogether, the Wagnephone manages to jump an octave higher or lower without the player moving an inch. All he has to do is lift one finger. Again, before discovering the magic principle, there are a few interesting facts to know about music in general.

Western music is based on major and minor keys which in turn are divided into tetrachords. C major, for instance, consists of the two tetrachords c-f and g-c. These have nothing to do with chords and are sequences of four notes. The first three notes are always separated by a whole tone, whereas the last two are a semitone away from each other. Thus, in the C major example, e and f on the one hand and b and c on the other are semitones. Together the two tetrachords constitute an octave.

Playing the C major scale up and down the piano requires a certain amount of practice until the right fingers instinctively hit the right note. Since a hand only has five fingers and a piano has many more keys, it is obvious the pianist soon runs out, which means tucking the thumb under in certain places (for which there are special rules). The inventor of the Wagnephone wished to reduce the number of physical movements involved in playing on an ordinary keyboard. As can be seen from the

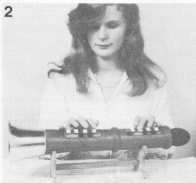

Figure 2. This is the seated position for playing the Wagnephone.

photograph, the Wagnephone keyboard is designed so that the four fingers (excluding the thumb) of the left hand cover the first tetrachord (c...f) and those of the right hand cover the second (g...c). Each finger thus has its own note and each hand its own tetrachord, making it so much easier to learn that within no time the player will be a musician 'to his/her fingertips'.

The Wagnephone and octave shift

Now that the principle behind the instrument is clear, what about the instrument itself? Does it accomplish what it sets out to do? The 'octave shift mechanism' that it incorporates is a very common organ stop and is simply a switch enabling the music to go up or down an octave without having to extend the keyboard range. The



Figure 3. If you wish to sing along, you can also stand like this.

Wagnephone's one and only octave is divided into two tetrachords. When these are covered by the fingers of both hands, the thumbs are free to depress the two pushbuttons conveniently positioned between the two rows of keys shown on the right-hand side of the photo in figure 2. In the photo all the fingers (except one) are held a little above the notes for clarity's sake. Usually, however, they will rest gently on the keys. As always, the black notes provide the semitones in keys other than C major.

Whenever the melody exceeds the single octave range, one of the thumbs will have to be depressed. If the music is to go up an octave the right-hand thumb will depress the pushbutton, if, on the other hand, the melody is to go down an octave, the left-hand thumb will depress the other switch. As soon as either switch is released, the original octave will return.

It will be clear from the above how little learning effort is entailed before the fingers race along the keys smoothly. Soon, for instance, the little finger on the right hand will become automatically associated with the upper C... and all without looking. You can't miss!

The person in figure 2 is shown to be seated as she would be to play the piano. For beginners this has the disadvantage that they will have to look up from the keys to read the notes. Once they have mastered this, they can easily change over to the piano or organ.

Reading music has always been considered a problem and there are plenty of skilled amateurs who manage without. Sometimes it is remedied by drawing the bars vertically rather than horizontally. In the case of the Wagnephone the difficulty just does not arise, as there is no need to keep an eye on the fingers (see figure 4).

The circuit

At the heart of the circuit diagram in figure 5 there are two function generators of the 8038 type. This IC was chosen for two reasons. First, it features excellent stability and is linear within a wide range. Second, it requires only very few external components, which means the circuit can be highly compact, easy to control, simple to build and requires very little calibration.

To start with, let's take a look at IC3. As usual the frequency of the 8038 is determined by an external RC network. In this case by C11 and the resistor network $R_C...R_H$ (either 1% or 5% types). According to which of the keys is depressed (C...C1) the resistor chain is connected to $+U_B$ at a certain point. The function generator then provides the corresponding frequency. The keyboard can be tuned with preset pot P_v. The LED, D1, shown in the diagram has a purely

4

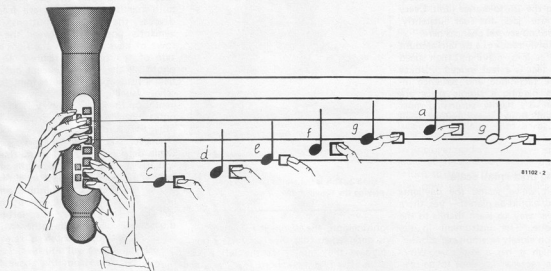

Figure 4. A pianist's eyes have to continually shift from the music to the keyboard. The Wagnephone is designed to reduce this considerably.

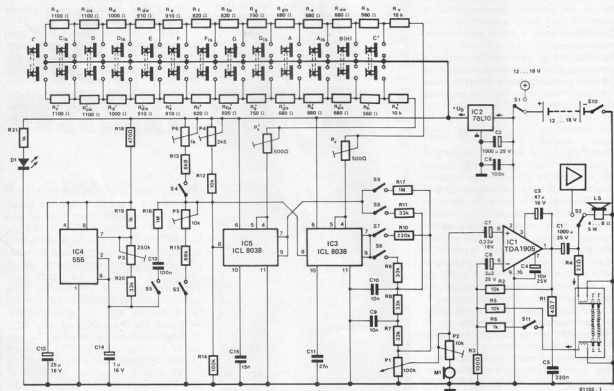

Figure 5. The circuit diagram. Tones are generated by two 8038 function generators. Switches S3 and S4 activate the 'octave shift mechanism'.

decorative purpose, lighting as soon as the supply voltage is switched on. The frequency can be obtained from the output of the 8038 (pin 9) in the form of a square wave voltage. At outputs 2 and 3 additional sine wave and triangular signals are available at the same frequency for those who enjoy experimenting.

Using the information given so far, all the notes of an octave can be played (including all the semitones, bringing the total up to 12). With the aid of input 8, which in principle is meant for frequency modulation purposes, the range can be moved either up or down an octave. Thus, the octave shift mechanism is very simple. If the voltage at pin 8 is decreased by way of the octave switch S3, the frequency will move up an octave; if the voltage is raised via S4, the frequency will drop an octave. The octave shift is tuned by means of P4, P5 and P6.

The filter which is connected to Pin 9 acts to 'shape' the sound. It mellows it somewhat - this effect can be partly counteracted, if necessary, with S7.

The second 8083 (IC5) is connected in parallel to IC3. This generator, however, is preset one octave higher and is shifted slightly in frequency (a few Hertz) by presetting P'v. This greatly improves the end product, for when IC5 is included, with the aid of S8 and S9 ('soft' or 'powerful') respectively, - just like S6 and S7), a very slight phasing effect is obtained and the tones sound fuller. The frequency determining capacitor C15 which is connected to pin 10 of IC5 has half the value of C11.

The wagnephone's is also largely dependent on the vibrato generated by IC4. An ordinary 555 has been used for this. C14, R20 and P3 determine the frequency, being several Hz. The output of the vibrato circuit is fed to the modulation input (pin 8) of IC3 and IC5. S5 enables the effect to be switched on and off.

In order to amplify the signal sufficiently to drive a loudspeaker an integrated power amplifier (IC1 = TDA 1905, SGS-ATES) has been included. This provides about 5 watts maximum output power. By inserting a springline reverb in the feedback network of the output amplifier the sound is further improved in quality. This effect can be adjusted in volume with S11. If required, a microphone can be connected to the input of IC1. If this is done in the manner suggested in figure 5, P2 can be used to mix the mike signal to the music. The type used in the prototype was an electret which included a FET preamplifier, not expensive nowadays and fairly easy to obtain.

Since IC1 fortunately is not sensitive to variations in supply voltage, only the voltage for the tone generators has to be stabilised and a simple IC stabiliser (IC2) will take care of this. As the

Wagnephone has been designed to be battery powered, current consumption is, of necessity, as low as possible. Quiescent current, or when headphones are used, is about 50 mA. This will of course after according to the volume preset with P1. The supply voltage must be between 12 and 18 V. The speaker used in the prototype was a special high frequency horn with a 15 watt rating. Together with the rest of equipment it constitutes a neat unit.

Expansion possibilities

The high quality sound (surprising considering its size) can be improved by connecting a good power amplifier and a couple of decent loudspeaker units, to the circuit. The improvement will be quite amazing, however, if a graphic equalizer is added. The equalizer input is then connected to the wiper of P1 and the signal processed by the equalizer is fed back to the input of IC1 or that of an external amplifier. This enables the Wagnephone to render very good imitations of instruments like the saxophone, clarinet and oboe. In fact the Wagnephone is almost a synthesizer. When a vocoder is connected to it, a whole range of special effects can be explored. This can include robot or Donald Duck type voices and serious musical effects. What's more the singer does not even have to be in tune, as the sound of his/her voice will be 'reformed' by the build-in microphone. **M**

bookshop

It is not often that a book is reviewed in Elektor but when a book arrives that fulfils a need by our readers we will comply in Bookshop.

We receive repeated requests for a book that is suitable for the electronics enthusiast or engineer with no formal training and for just such a role this book is ideal.

THE ART OF ELECTRONICS is a text/reference book that emphasizes electronic circuit design techniques and scientific measurements. It begins at a level suitable for those with no previous exposure to electronics and takes the reader through to a reasonable level of design proficiency, emphasizing the techniques used daily by circuit designers. Circuit intuition and nonmathematical design techniques are emphasized, rather than the more traditional textbook subjects of network theory, the *h*-parameter model, the *s*-plane, solid-state physics, and the like. Topics covered include both linear (transistors, FET's, op amps) and digital electronics including minicomputers and microprocessors), with additional chapters on active filters, voltage regulators, low-noise and precision design, radiofrequency and high-speed switching circuits, and construction techniques. The book concludes with a chapter on scientific measurements and signal processing.

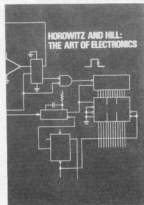

The approach is one of simplicity and practicality.

The overall intent is to bring the reader to the point of understanding clearly the choices one makes in designing a circuit - how to choose circuit configurations, device types, and parts values. There are numerous design examples, with particular emphasis on the choice of circuit configurations and components, and resulting performance tradeoffs. In both the circuit examples and ensuing discussion devices are called out by name, with more than forty up-to-date tables listing characteristics of available components.

The Art of Electronics is suitable as a reference for those educated in an earlier technology, a valuable reference book for the practising engineer, and a stand-alone sourcebook with which the intelligent and motivated reader can learn the subject.

This book might be considered fairly expensive at £ 12.50 but for 716 pages of good, sound, basic and not so basic electronic theory, it is an investment.

THE ART OF ELECTRONICS,
Horowitz and Hill,
Cambridge University Press. £ 12.50,
ISBN 0 521 29837 7

market

8 MM thumbwheel switch

The 1800 Series sub-miniature thumbwheel switches from EECO eliminate the need for tools or mounting hardware... the slim 8 mm width switch is simply snapped into place from the front panel. Outstanding legibility is provided by the large 5.94 mm characters. A variety of binary and decimal codes are offered, in 10 switching positions. Weighing 4 grams, the 1800 Series switch lasts more than 500,000 detent operations and comes with a one-year warranty.

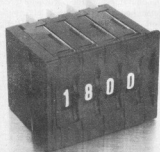

The switch is available in three colours and three finishes — gloss, semi-gloss and matt. Options include: decimal points, custom dial markings, stops to limit rotation, and provisions for diodes. Printed circuit board mounting pins are also available, and a PC board allows direct wire or connector termination.

Roy Loudon,
EECO,
25 Viking Way,
Bar Hill,
Cambridge CB3 8EL,
England.
Telephone: (0954) 90257

(1836 M)

Miniature electric drill

A powerful miniature electric drill with a 3 mm chuck capacity has been introduced by West Hyde Developments Ltd. for precision work in such diverse fields as electronics, school laboratories and model-making. In electronics, for example, it has particular application on printed circuit boards and other components, wherever very fine and accurate control is required.

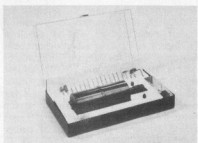

Called the Titan, this high quality drill has a well-balanced cylindrical body measuring just 114 mm in diameter, and is light and easy to use with either hand. It is supplied complete with a comprehensive tool kit, enabling a variety of tasks to be undertaken. In addition to collets and eight twist drills for boring holes up to 3 mm in diameter in a wide selection of materials, there are a further 12 assorted tools including wire brushes, grinding discs and burrs. Further accessories are available including slitting saws in three sizes, carborundum slitting discs, top quality high-speed twist drills in sizes from 0.6 to 1.6 mm and a sturdy metal drill stand for vertical or horizontal mounting. Operating on a 12 V DC supply, the Titan can be powered direct from a car battery or from the normal mains supply using an optional, purpose-designed power supply. This unit has a useful variable speed control and incorporates thyristor circuitry to give stall-free performance at low speeds. The complete Titan drill kit, including a useful carrying case, is priced at £ 19.50 excluding VAT. The optional power supply costs £ 13.50 excluding VAT.

Mr. C. Long,
West Hyde Developments Ltd.,
Unit 9 Park Street Ind. Estate,
Aylesbury, Bucks.
Telephone: Aylesbury (0296) 20441

(1832 M)

Backplane socket connectors

The Scotchflex Backplane System features a 40-way socket and keying header which allows direct interface with a '025" square backplane with wire wrap pins on '100" x '200" spacing. The socket uses the Scotchflex beryllium copper 'U' element contacts and will accept .50" pitch flat cable in 26 AWG, 28 AWG and 30 AWG solid or 26 AWG and 28 AWG stranded styles.

Polarising to backplanes is easily accomplished with the keying headers. These moulded plastic components are placed directly over the wrap pins and assist in

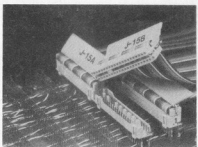

keeping them straight. Their unique design includes posts on opposite corners for aligning them over the pins. The posts serve as a depth guide for '237" engagement, eliminating the need to cut the pins and allowing for two layers of wire-wrap below the header. They also interface with notched corners on the socket connectors to provide orientation.

Rectangular keying posts in the centre of the header can be broken off to allow positive keying of the socket connector. A polarising key is inserted into the keying posts on the socket for totally mistake-proof polarisation.

Ken Adams,
Electronic Products Group,
3M United Kingdom Ltd,
3M House,
PO Box 1,
Bracknell Berks RG12 1JU,
Telephone: Bracknell (0344) 58436

(1833 M)

Sub-Miniature Locking Dial

The LK 13 is only 13 mm square and is the latest and smallest of the precision locking dials designed and manufactured by Argo Electronic Components Ltd. of Westcliff-on-Sea.

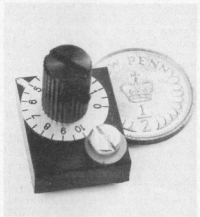

This new attractive sub-miniature locking device has a moulded backplate incorporating a locking screw and datum line. The knob is black anodised aluminium and the dial plate has durable photo-anodised markings. Two accurate standard dials, graduations are available, 0-10 over 270° and 0-100 over 300°. Non-standard dials are also available to customers' specifications.

The locking dial is suitable for use with components incorporating 3 mm, 4 mm or 1/8 shaft.

Argo Electronic Components Ltd.,
Electric Avenue,
Westcliff-on-Sea,
Essex, SSO 9NW.
Telephone: (0702) 43355

(1844 M)

market

market

HF digital frequency counter

High-quality 8-digit frequency counters for sine or square wave inputs from B. Davis Electronics, start at only £ 116 for a 60 MHz instrument with a resolution down to 10 Hz.

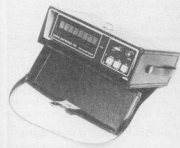

An integral x 10 prescaler/amplifier widens the range to 600 MHz and a crystal oven increases initial accuracy from ± 1 ppm to ± 0.2 as well as making readings practically independent of ambient temperature. Both options can be factory retrofitted. The 8-digit display is by seven-segment $\frac{1}{2}$ in LEDs using the latest reflector technology for utmost clarity. Power requirements are ac mains or 9 - 16 V dc. For bench use, tilt legs are provided and a carrying case is also available.

B. Davis Electronics Ltd,
Brett Drive,
Bexhill-on-Sea TN40 2JR.
Telephone: 0424 216611

(1837 M)

The different shapes make ideal function indicators or, in the case of the 'squares and flats', can be end stacked to form bar graphs.

Mr. Allan Cowley,
C.R.P. Electronics Ltd.,
13 Hazelbury Crescent,
Luton LU1 1DF.
Telephone: Luton (0582) 411085

(1840 M)

Power FETs

Four new power MOS field-effect transistors (MOS FETs) are the first of a line from Hewlett-Packard. Primarily designed for use in off-line switching power supplies, power inverters and converters, these new devices also can be used in ultrasonic transducer drives, audio amplifiers and general industrial high-speed power switching applications. Called Hewlett-Packard's HWPR-65XX family, these new Power FETs feature high breakdown voltage to allow greater design margin and low on-resistance for low-power dissipation. Features inherent in Power MOS FETs are:

- Fast switching speeds when driven by simple, lower power gate drive circuits; unlike power switching bipolar transistors which generally need complex, higher-power drive circuits to achieve fast switching speeds.
- Switching speeds are virtually independent of operating chip temperature; unlike power bipolars, whose switching speeds

increase markedly with chip temperature, causing problems for circuit designers.

- No 'second breakdown' phenomenon to limit Safe Operating Area, unlike bipolar power transistors which are severely SOA limited by 'second breakdown' ($I_{S/B}$).
- Easy to operate in parallel for high-current circuits. Positive temperature coefficient of $R_{(on)}$ and negative temperature coefficient of gain combine to provide inherent tendency to equalise currents between paralleled Power MOS FETs. This contrasts with bipolars, which operate in the opposite way with the tendency for one of several paralleled bipolars to end up 'hogging the current'.

Four devices presently available have the following key specifications:

	V_{DSS} (min)	$R_{(on)}$ (max)
HPWR-6501	450 V	.85 Ω
HPWR-6502	400 V	.75 Ω
HPWR-6503	450 V	1.0 Ω
HPWR-6504	400 V	1.0 Ω

All four of these HP Power MOS FETs are available in the industry-standard TO-3 steel hermetic package, rated at 90 watts DC dissipation.

Chips are fabricated with planar, double-diffused ('DMOS') design. They all feature guard-ring structure for high voltage capability, providing reliable operation in industrial applications.

Hewlett-Packard Limited,
King Street Lane, Winnersh,
Wokingham, Berkshire RG11 5AR.
Telephone: (0734) 784774.

(1763 M)

Sharp's special shapes

In addition to conventional tubular L.E.D. lamps, SHARP CORPORATION offer a range of special shapes. Designed for flush fitting in front panels, the shapes presently offered include round 'point' indicators, equilateral and isosceles triangles, square and flat sections in three different sizes (basically 3, 4 and 5 mm) and colours (red, yellow and green).

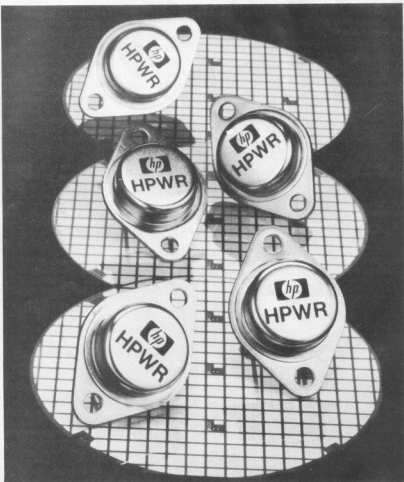
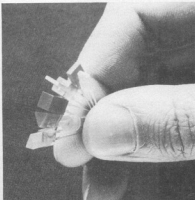

market

Sensitive ultrasonic transducers

A new series of matched, low-cost ultrasonic transducers from Impectron Limited are small, light and highly sensitive. They offer excellent performance in applications such as industrial control and intruder detection systems.

The EFR-OCB25K5 and EFR-RCB25K5 are transmitter and receiver respectively, with centre frequency of nominally 25 kHz. Sensitivity is around $-65 \text{ dB/V}/\mu\text{bar}$ with minimum bandwidth of 3 kHz. Overall dimensions are 1 inch long (body length 0.37") by 0.95 inch diameter for both receiver and transmitter.

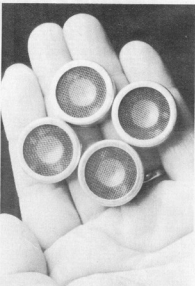

Internal construction of these low cost items incorporates a compound vibrator (ceramic chip plus conical aluminium resonator) providing sensitivity and wide bandwidth, while the choice of body material and assembly methods ensure a long life even in demanding environments.

*Impectron Limited,
Foundry Lane,
Horsham,
W. Sussex RH13 5PX.
Telephone: (0403) 50111*

(1771 M)

Subminiature and microminiature lamps

New from Diamond H is a complete range of incandescent lamps ranging in size from $T\frac{1}{8}$ to $T1\frac{1}{2}$ styles, and from 0.13 to 0.65 inch length overall.

These new sub-miniature and micro-miniature lamps offer the options of supported or unsupported filament coils, lens tips or smooth

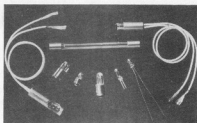

'tipless' construction for undistorted end-on viewing, and clear or colour-coated glass envelopes.

All lamps can be supplied with wire terminations or popular base styles, including proprietary all-glass integral pin versions. Conventionally, their leads are tin plated to MIL specifications, though versions with the leads gold plated to MIL specifications are also available.

Voltage, current and light output specifications for the range cover an extremely broad spectrum of application requirements, and life expectancy extends beyond 100,000 hours.

Each lamp is evaluated following a minimum burn-in period of 16 hours at the rated voltage, and so offers a very high degree of reliability.

*Diamond H Controls Ltd.,
Vulcan Road North,
Norwich NR6 6AH.
Telephone: Norwich (0603) 45291/9*

(1847 M)

Portable E-PROM Programmer

A new portable E-PROM Programmer with built-in power supply is now available from Chiptech Limited, Welwyn Garden City, Herts. The PKW5000 is capable of programming devices up to 32 K bits including the 2708, 2716, 2516 and the 2532 E-PROMs. Selection of the appropriate device programming routine is by means of switches on the front panel.

Based on the Z80 microprocessor, the PKW5000 includes keyboard function commands such as load, write, erase check, compare and buffer clear as well as data entry and various editing functions through the RAM buffer. A 16 digit hex display provides address

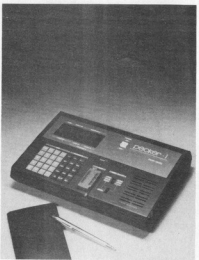

and data information and it also shows the E-PROM type selected for programming. An audible warning is provided to confirm keyed-in operation, completion of programming and the occurrence of errors.

In addition to its programming capability, the PKW5000 may be used to run and debug Z80 programs with readout of all registers and insertion of up to two breakpoints.

An optional I/O card will expand the capability of the PKW to provide additional facilities allowing interface to a 150 cps tape reader, a 20 mA current loop or RS232C serial interface. The option also contains sockets which can accept pre-programmed E-PROMS containing an assembler, debug program or BASIC.

*Chiptech Limited,
Tewin Court,
Welwyn Garden City,
Hertfordshire AL7 1AU.
Telephone: (07073) 33260*

(1843 M)

ABS plastic keyboard enclosure

West Hyde Developments Limited have added a purpose-designed keyboard enclosure to their Princess range.

This extremely lightweight yet robust enclosure provides a cost-effective and simple approach to mounting a full alpha-numeric keyboard which will blend with any associated hardware such as VDU screens. The unit is produced from textured ABS plastic and is available in black, or in a wide variety of other colours for quantity orders.

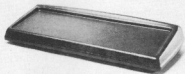

The Princess keyboard's overall measurements are 435 mm long, 205 mm deep and 70 mm high. The 380 mm recessed area allows plenty of room for cutting out apertures to take the keyboard assembly.

Made in Britain, the enclosure is vacuum-formed in two halves which are clipped and then screwed together for rigidity in final assembly. The ABS plastic is easy to drill, punch and clean while the base contains a series of ribs for simple mounting of many proprietary keyboard assemblies. A single Princess keyboard costs £ 10.75 plus VAT.

*Chris Long, Sales Manager,
West Hyde Developments Ltd.,
Unit 9, Park St. Ind. Est.,
Aylesbury, HP20 1ET.
Telephone: Aylesbury (0296) 20441*

(1839 M)

market

market

100 CPS bidirectional printer

The MPI Model 88T bidirectional impact printer from Impetron Limited, is capable of printing at up to 100 characters per second on roll paper, fan-fold forms or cut sheets, using either a pressure roll feed or tractor feed system. The adjustable tractors allow printing on pre-printed forms or continuous labels, varying from 1" to 9.5" in width. An easily inserted long-life ribbon cartridge eliminates messy ribbon changing.

Selectable character densities allow formatting of output in either 80, 96, or 132 character lines. Double width characters are software selectable for any of the three character densities and can be intermixed on a line for message high-lighting. A full upper and lower case 96 character ASCII set is printed in a 7 x 7 matrix to provide crisp, clear copy on the original and up to two copies. The simplicity of the print mechanism and the maximum use of LSI chips on a single printed circuit board combine to give high reliability and ease of maintenance without sacrificing capability.

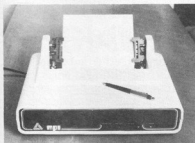

Data input may be either serial (RS232C or 20 ma current loop) or parallel (Centronics compatible 7-bit ASCII) with a standard two line buffer. Paper feed is up to 10 lines/second, resulting in high print throughput, and the machine incorporates a push-button operated selftest facility.

*Impetron Limited,
Foundry Lane,
Horsham,
W. Sussex, RH13 5PX.
Tel: 0403-50111*

(1842 M)

Low-cost terminal blocks

H & T Components have introduced a series of terminal blocks specifically designed for high density applications in electrical and electronic equipment. The 250 D series terminal block is moulded in glass-filled nylon, or glass-filled polyester approved to UL94VO standards. Versions are available with from one to 12 channels, inclusive, and in up to five styles, according to the requirements of the applications. These styles include screw and stud inserts; lead-through terminations, with or without connector tabs;

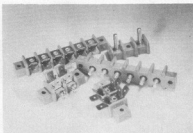

and single or multiple connector tabs secured by either a hollow or solid rivet.

Designed to provide ease of accessibility to the connector tabs, the 250 D series is well suited for high-speed or mass assembly work in both domestic and commercial equipment. Their connector terminals are of the standard 6.3 x 0.8 mm size, and offer the possibility of up to six terminations per cavity. The compact design of the terminal block, which is only 13 x 13 mm in section, means that it may be used in any application in which space is extremely restricted. Typical electrical characteristics of the series include a maximum working voltage of 240 V and a maximum current rating of 25 A.

*H & T Components,
Crowdy's Hill Estate,
Kembrey Street,
Swindon,
Wiltshire SN2 6BN.
Telephone: Swindon (0793) 693681-7*

(1838 M)

market

Keyboard switches

Two ranges of keyboard switches which offer the user the options of standard or low profile construction are available from Diamond H. The Series 400 and 475 keyboard switches, with their low-profile equivalents, the 415 Series, are similar in their basic construction and feature contact ratings of 5 V d.c. resistive, at 100 mA with a breakdown voltage in excess of 500 V a.c.; Contact resistance is less than 100 milliohms throughout the life of the switch, and contact bounce is less than 3 milliseconds. Both normally-open and normally-closed versions are available, and each version has a total key travel of 0.125 in. Both Series are fitted with plug-in printed circuit terminals, and embody a snap-in



feature for panel mounting. Available contact configurations are SPST and DPST, normally open or normally closed. Additionally, the 400 Series offers alternate (push-push) action. They may be supplied with a broad range of key tops to satisfy a wide variety of requirements in equipment ranging from data terminals to video games consoles. Their overall height ranges from 0.41 to 0.467 in., including the keytop, and they are designed for mounting directly onto the printed circuit board.

*Diamond H Controls Ltd.,
Vulcan Road North,
Norwich NR6 6AH.
Telephone: Norwich (0603) 45291/9*

(1834 M)

Miniature DIP rotary switches

P. Caro and Associates Ltd have introduced a new range of binary coded DIP rotary switches. These switches are manufactured by Copal Electronics of Japan and are available in two ranges: either hexadecimal (16 position) or decimal (10 position) in either open or closed contact variations. These are designated as types S-1000 and S-2000 series respectively. They are particularly compact in size, with bodies only 10 mm square. There are alternative top or side adjustment models in both ranges and the S-200 series have optional extended knurled adjusters for manual setting. The arrow position indicators are recessed to take a screwdriver head and a click action ensures positive location of each switch position.

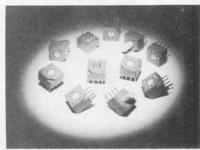

Contact pins are compatible with conventional DIP switches and the sealing features ensure that they are gas and solvent proof. A considerable amount of mechanical and electrical stability is claimed for these switches which are designed to withstand soldering heat at any setting position.

*P. Caro & Associates Ltd,
2347 Coventry Road,
Sheldon,
Birmingham B26 3LS.
Telephone: 021 - 742 1328*

(1835 M)

market

market

'Scope for servicemen, industry and Hobbyists

The new Model SB 3 M oscilloscope from Albol Electronic will serve most purposes required by industrial and service and hobby engineers, and yet manages to keep on the right side of the significant £100 price barrier. With a bandwidth of 0 to 3 MHz at -3 dB (extending to 6 MHz at -6 dB), the SB 3 M breaks new ground, in its class, by offering time-base automatic triggering by IC comparator control of the type usually fitted

and it has four switchselectable calibration speeds, from 1 μ s/cm to 5 ms/cm. A six-stage attenuator, from X 1 to X 10, can be applied to each.

Triggering, which can be either internal or external, can be polarised positive or negative, in the range 10 Hz to 500 kHz. If internal synchronisation is used the range extends from 10 Hz to 3 MHz. The internal trigger threshold is 5 mV, and the external 100 mV. The SB 3 M takes about 20 watts from the 240 V mains, weighs 4.5 kg, and measures 150 mm wide by 340 mm deep by 280 mm high. Price: £ 99.00 plus VAT.

*Albol Electronic & Mechanical Products Ltd.,
3 Crown Buildings,
Crown St.,
London SE5 0JR.
Telephone: 01-703 2311*

(1841 M)

A touch test meter

A completely new instrument from Non Linear Systems measures 10 parameters, 20 functions on 44 ranges.

The TOUCH TEST 20 is a 3½ digit multimeter with 0.55" LED display and front panel touch keyboard for selection of function and range. On selecting the desired function the least sensitive range is automatically displayed. Optimum display reading is obtained by touching the decade touch pads. The selection of function and range is indicated by an audible tone and illuminated LED at each pad. In addition to the usual multimeter functions, the TT20 measures capacitance (1 pF - 200 μ F); temperature (-40 to +150°C); conductance (0.01 nS - 1.999 nSiemens); diode test and audible continuity test.

Voltage ranges are 10 μ V - 1 kV DC (0.2%); 10 μ V - 750 V RMS.

Current 0.01 μ A - 10 A DC and 10 μ A - 10 A AC.

Resistance 10 Mohms - 20 Mohms.

The TT20 is available as mains only or rechargeable battery mains, it measures only 2.9 x 6.3 x 7.5" and weighs less than 31 bs without batteries.

Price £ 195.00 or £ 215.00 with batteries and charger.

*Lawtronic Limited,
139 High Street,
Edenbridge-Kent TN8 5AX.
Telephone: Edenbridge 0732-865191*

(1846 M)

only to luxury 'scopes. A 10 mV signal is all that is needed for a firmly locked and triggered time-base.

The measuring field on the c.r.t. is 50 by 60 mm, and the deflection sensitivities are selectable (by push-button) from 0.05 to 20 V/cm. Calibration accuracy is $\pm 5\%$ and the input characteristics are 1 megohm $\pm 5\%$, and 30 pF $\pm 10\%$. The time-base can be either automatically triggered or synchronised,

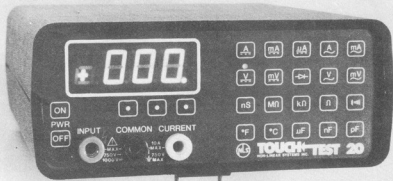

missing link

Digital heart beat monitor (Summer Circuits '80)

In the circuit diagram pin 10 of IC7 is shown incorrectly connected to pin 3. The correct link should be between pins 10 and 6. The printed circuit board, however, is correct.



Programmable slide fader

Triacs Tri1 and Tri2 are drawn incorrectly in the component overlay of the article published in October '80 (E66, p. 10-05). These should be turned 180° degrees.

In addition, the 24 V voltage connections are missing. The drawing below shows what the circuit should look like.

If the bulbs do not fade on and off smoothly, this can be remedied by placing a D type flip-flop between N6 and IC3, as follows:

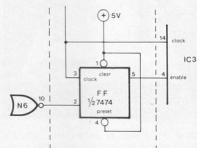

81002L

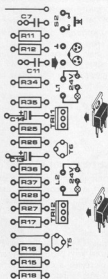

ELEKTOR BOOK SERVICE



SC/MPUTER (1) — describes how to build and operate your own microprocessor system — the first book of a series — further books will show how the system may be extended to meet various requirements.

Price — UK£3.70 Overseas £3.90

FORMANT — complete constructional details of the Elektor Formant Synthesiser — comes with a FREE cassette of sounds that the Formant is capable of producing together with advice on how to achieve them.

Price — UK£4.50 Overseas £4.70

300 CIRCUITS for the home constructor — 300 projects ranging from the basic to the very sophisticated.

Price — UK£3.50 Overseas £3.70

DIGIBOOK — provides a simple step-by-step introduction to the basic theory and application of digital electronics and gives clear explanations of the fundamentals of digital circuitry, backed up by experiments designed to reinforce this newly acquired knowledge — supplied with an experimenter's PCB.

Price — UK£5.00 Overseas £5.20

BOOK 75 — a selection of some of the most interesting and popular construction projects that were originally published in Elektor issues 1 to 8.

Price — UK£3.50 Overseas £3.70

When ordering please use the Elektor Readers' Order Card in this issue (the above prices include p. & p.)